

Keysight U1281A/U1282A Handheld Digital Multimeter

Notices

Copyright Notice

© Keysight Technologies 2015 - 2016

No part of this manual may be reproduced in any form or by any means (including electronic storage and retrieval or translation into a foreign language) without prior agreement and written consent from Keysight Technologies as governed by United States and international copyright laws.

Trademark

Bluetooth and the *Bluetooth* logos are trademarks owned by Bluetooth SIG, Inc., U.S.A. and licensed to Keysight Technologies.

Manual Part Number

U1281-90003

Edition

Edition 02, March 31, 2016

Printed in:

Printed in Malaysia

Published by:

Keysight Technologies
Bayan Lepas Free Industrial Zone,
11900 Penang, Malaysia

Technology Licenses

The hardware and/or software described in this document are furnished under a license and may be used or copied only in accordance with the terms of such license.

Declaration of Conformity

Declarations of Conformity for this product and for other Keysight products may be downloaded from the Web. Go to <http://www.keysight.com/go/conformity>. You can then search by product number to find the latest Declaration of Conformity.

U.S. Government Rights

The Software is "commercial computer software," as defined by Federal Acquisition Regulation ("FAR") 2.101. Pursuant to FAR 12.212 and 27.405-3 and Department of Defense FAR Supplement ("DFARS") 227.7202, the U.S. government acquires commercial computer software under the same terms by which the software is customarily provided to the public. Accordingly, Keysight provides the Software to U.S. government customers under its standard commercial license, which is embodied in its End User License Agreement (EULA), a copy of which can be found at <http://www.keysight.com/find/sweula>. The license set forth in the EULA represents the exclusive authority by which the U.S. government may use, modify, distribute, or disclose the Software. The EULA and the license set forth therein, does not require or permit, among other things, that Keysight: (1) Furnish technical information related to commercial computer software or commercial computer software documentation that is not customarily provided to the public; or (2) Relinquish to, or otherwise provide, the government rights in excess of these rights customarily provided to the public to use, modify, reproduce, release, perform, display, or disclose commercial computer software or commercial computer software documentation. No additional government requirements beyond those set forth in the EULA shall apply, except to the extent that those terms, rights, or licenses are explicitly required from all providers of commercial computer software pursuant to the FAR and the DFARS and are set forth specifically in writing elsewhere in the EULA. Keysight shall be under no obligation to update, revise or otherwise modify the Software. With respect to any technical data as defined by FAR 2.101, pursuant to FAR 12.211 and 27.404.2 and DFARS 227.7102, the U.S. government acquires no greater than Limited Rights as defined in FAR 27.401 or DFAR 227.7103-5 (c), as applicable in any technical data.

Warranty

THE MATERIAL CONTAINED IN THIS DOCUMENT IS PROVIDED "AS IS," AND IS SUBJECT TO BEING CHANGED, WITHOUT NOTICE, IN FUTURE EDITIONS. FURTHER, TO THE MAXIMUM EXTENT PERMITTED BY APPLICABLE LAW, KEYSIGHT DISCLAIMS ALL WARRANTIES, EITHER EXPRESS OR IMPLIED, WITH REGARD TO THIS MANUAL AND ANY INFORMATION CONTAINED HEREIN, INCLUDING BUT NOT LIMITED TO THE IMPLIED WARRANTIES OF MERCHANTABILITY AND FITNESS FOR A PARTICULAR PURPOSE. KEYSIGHT SHALL NOT BE LIABLE FOR ERRORS OR FOR INCIDENTAL OR CONSEQUENTIAL DAMAGES IN CONNECTION WITH THE FURNISHING, USE, OR PERFORMANCE OF THIS DOCUMENT OR FOR ANY INFORMATION CONTAINED HEREIN. SHOULD KEYSIGHT AND THE USER HAVE A SEPARATE WRITTEN AGREEMENT WITH WARRANTY TERMS COVERING THE MATERIAL IN THIS DOCUMENT THAT CONFLICT WITH THESE TERMS, THE WARRANTY TERMS IN THE SEPARATE AGREEMENT SHALL CONTROL.

Safety Information

CAUTION







A CAUTION notice denotes a hazard. It calls attention to an operating procedure, practice, or the like that, if not correctly performed or adhered to, could result in damage to the product or loss of important data. Do not proceed beyond a CAUTION notice until the indicated conditions are fully understood and met.

WARNING

A WARNING notice denotes a hazard. It calls attention to an operating procedure, practice, or the like that, if not correctly performed or adhered to, could result in personal injury or death. Do not proceed beyond a WARNING notice until the indicated conditions are fully understood and met.

Safety Symbols

The following symbols on the instrument and in the documentation indicate precautions which must be taken to maintain safe operation of the instrument.

 Direct current (DC)	 Alternating current (AC)
 Caution, risk of electric shock	 Caution, risk of danger (refer to this manual for specific Warning or Caution information)
 Earth (ground) terminal	 Equipment protected throughout by double insulation or reinforced insulation
CAT III 1000 V Category III 1000 V overvoltage protection	CAT IV 600 V Category IV 600 V overvoltage protection

Safety Considerations

Read the information below before using this instrument.

The following general safety precautions must be observed during all phases of operation, service, and repair of this instrument. Failure to comply with these precautions or with specific warnings elsewhere in this manual violates safety standards for design, manufacture, and intended use of the instrument. Keysight Technologies assumes no liability for the customer's failure to comply with these requirements.

WARNING

- Do not exceed any of the measurement limits defined in the specifications to avoid instrument damage and the risk of electric shock.
- Do not use the multimeter if it is damaged. Before you use the multimeter, inspect the case. Look for cracks or missing plastic. Pay particular attention to the insulation surrounding the connectors.
- Inspect the test leads for damaged insulation or exposed metal. Check the test leads for continuity. Replace damaged test leads before you use the multimeter.
- Do not operate the multimeter around explosive gas, vapor, or wet environments.
- Do not apply more than the rated voltage (as marked on the multimeter) between terminals, or between terminal and earth ground.
- Never use the multimeter in wet conditions or when there is water on the surface. If the multimeter is wet, ensure that the multimeter is dried only by trained personnel.
- Before use, verify the multimeter's operation by measuring a known voltage.
- When measuring current, turn off the circuit power before connecting the multimeter in the circuit. Remember to place the multimeter in series with the circuit.
- When servicing the multimeter, use only the specified replacement parts.
- Use caution when working above 60 V DC, 30 V AC rms, or 42.4 V peak. Such voltages pose a shock hazard.
- When using the probes, keep your fingers behind the finger guards on the probes.
- Connect the common test lead before you connect the live test lead. When you disconnect the leads, disconnect the live test lead first.
- Remove the test leads from the multimeter before you open the battery cover.
- Do not operate the multimeter with the battery cover or portions of the cover removed or loosened.
- To avoid false readings, which may lead to possible electric shock or personal injury, replace the battery as soon as the low battery indicator appears and flashes.
- Only probe assemblies with Measurement Category III or IV ratings should be used for mains measurements.

CAUTION

- Disconnect circuit power and discharge all high-voltage capacitors before testing resistance, continuity, diodes, or capacitance.
 - Use the proper terminals, function, and range for your measurements.
 - This multimeter is for use at altitudes of up to 3000 m.
 - Never measure voltage when the current measurement is selected.
 - Always use the specified battery type. The power for the multimeter is supplied with four standard 1.5 V AA batteries. Observe the correct polarity markings before you insert the batteries to ensure proper insertion of the batteries in the multimeter.
-

Measurement Category

The U1281A/U1282A has a safety rating of CAT III, 1000 V and CAT IV, 600 V.

Measurement CAT I Measurements performed on circuits not directly connected to the AC mains. Examples are measurements on circuits not derived from the AC mains and specially protected (internal) mains-derived circuits.

Measurement CAT II Measurements performed on circuits directly connected to a low-voltage installation. Examples are measurements on household appliances, portable tools, and similar equipment.

Measurement CAT III Measurements performed in the building installation. Examples are measurements on distribution boards, circuit-breakers, wiring, including cables, bus-bars, junction boxes, switches, socket outlets in the fixed installation, and equipment for industrial use, and some other equipment including stationary motors with permanent connection to the fixed installation.

Measurement CAT IV Measurements performed at the source of the low-voltage installation. Examples are electricity meters and measurements on primary overcurrent protection devices and ripple control units.

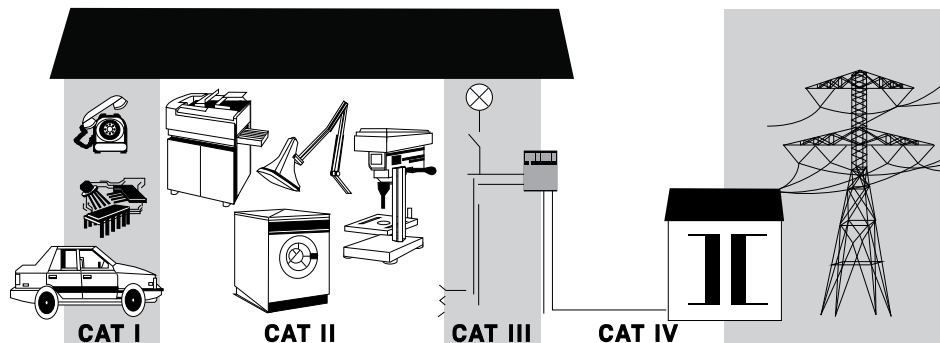

Environmental Conditions

The U1281A/U1282A is designed for indoor use and in an area with low condensation. The table below shows the general environmental requirements for this instrument.

Environmental condition	Requirement
Temperature	Operating condition - -20 °C to 55 °C, 0% to 80% RH (non-condensing)
	Storage condition - -40 °C to 70 °C, 0% to 80% RH (without batteries)
Humidity	Full accuracy up to 80% RH (relative humidity) for temperature up to 30 °C, decreasing linearly to 50% RH at 55 °C
Altitude	Up to 3000 meters
Pollution degree	2

Regulatory Information

The U1281A/U1282A complies with the following Electromagnetic Compatibility (EMC) and safety compliances:







Safety compliance

- IEC/EN 61010-1:2010 (3rd Edition)
- IEC/EN 61010-2-033:2012 (First Edition)
- CAN/CSA-C22.2 No. 61010-1-12
- CAN/CSA-C22.2 No. 61010-033-12
- ANSI/UL Std. No. 61010-1-12
- ANSI/UL Std. No. 61010-033-12

EMC compliance

- IEC 61326-1:2012/EN 61326-1:2013
- ICES/NMB-001: Issue 4, June 2006
- AS/NZS CISPR 11:2004

Regulatory Markings

	<p>The CE mark is a registered trademark of the European Community. This CE mark shows that the product complies with all the relevant European Legal Directives.</p> <p>ICES/NMB-001 indicates that this ISM device complies with the Canadian ICES-001.</p> <p>Cet appareil ISM est conforme a la norme NMB-001 du Canada.</p>		<p>The CSA mark is a registered trademark of the Canadian Standards Association.</p>
	<p>This instrument complies with the WEEE Directive (2002/96/EC) marking requirement. This affixed product label indicates that you must not discard this electrical or electronic product in domestic household waste.</p>		<p>The RCM mark is a registered trademark of the Spectrum Management Agency of Australia. This signifies compliance with the Australia EMC Framework regulations under the terms of the Radio Communication Act of 1992.</p>
	<p>This symbol indicates the time period during which no hazardous or toxic substance elements are expected to leak or deteriorate during normal use. Forty years is the expected useful life of the product.</p>		<p>This symbol is a South Korean Class A EMC Declaration. This is a Class A instrument suitable for professional use and in electromagnetic environment outside of the home.</p>

Waste Electrical and Electronic Equipment (WEEE) Directive 2002/96/EC

This instrument complies with the WEEE Directive (2002/96/EC) marking requirement. This affixed product label indicates that you must not discard this electrical or electronic product in domestic household waste.

Product category

With reference to the equipment types in the WEEE directive Annex 1, this instrument is classified as a “Monitoring and Control Instrument” product.

The affixed product label is as shown below.



Do not dispose in domestic household waste.

To return this unwanted instrument, contact your nearest Keysight Service Center, or visit <http://about.keysight.com/en/companyinfo/environment/takeback.shtml> for more information.

Sales and Technical Support

To contact Keysight for sales and technical support, refer to the support links on the following Keysight websites:

- www.keysight.com/find/U1281A
www.keysight.com/find/U1282A
(product-specific information and support, software and documentation updates)
- www.keysight.com/find/assist
(worldwide contact information for repair and service)

Table of Contents

Safety Symbols	3
Safety Considerations	4
Measurement Category	6
Environmental Conditions	7
Regulatory Information	8
Regulatory Markings	9
Waste Electrical and Electronic Equipment (WEEE) Directive 2002/96/EC	10
Product category	10
Sales and Technical Support	10
1 Introduction	
About This Manual	20
Documentation map	20
Safety notes	20
Preparing Your Multimeter	21
Check the shipment	21
Removing the holster	21
Installing the holster	22
Installing the batteries	22
Turn on your multimeter	25
Automatic power-off	25
Enabling the backlight	25
Selecting the range	26
Alerts and warnings during measurement	27
Adjusting the tilt stand	29
Remote communication	30
Power-on options	32
Your Multimeter in Brief	33
Overview	33
Rotary switch	35
Keypad	36
Display screen	40
Input terminals	45
Using the Remote Switch Probe	47
Cleaning Your Multimeter	48
2 Making Measurements	
Crest Factor	50

Measuring AC Voltage	51
Using the LPF Function for AC measurements (for U1282A only)	53
Measuring DC Voltage	55
Measuring AC and DC Signals	57
Using the LPF (Low Pass Filter) Function for AC+DC measurements	59
Making dB Measurements	60
Measuring Resistance	62
Measuring conductance	64
Testing for Continuity	65
Testing Diodes	68
Frequency Counter (for U1282A only)	72
Measuring Capacitance	74
Measuring Temperature	76
Temperature measurement without ambient compensation	79
Measuring AC or DC Current	80
% Scale of 4-20 mA or 0-20 mA	84
Measuring Frequency	87
Measuring pulse width	90
Measuring duty cycle	91
Square Wave Output	92

3 Multimeter Features

Non-Contact AC Voltage Detection (Vsense)	96
Making Relative Measurements (Null)	98
Capturing Maximum and Minimum Values (MaxMin)	100
Capturing Peak Values (Peak)	102
Freezing the Display (TrigHold and AutoHold)	104
Recording Measurement Data (Data Logging)	105
Performing manual logs (HAnd)	106
Performing interval logs (AUto)	106
Performing event logs (triG)	108
Performing export logs	109
Reviewing Previously Recorded Data (View)	111
Sanitizing the Log Memories	112

4 Multimeter Setup Options

Using the Setup Menu	114
Editing numerical values	115

Setup Menu Summary	116
Setup Menu Items	119
Changing the variation count	119
Enabling smooth mode	120
Changing the Auto Power-Off and backlight timeouts	121
Changing the recording option	122
Changing the sample interval duration	123
Setting a custom dBm reference impedance	124
Changing the thermocouple type	125
Changing the temperature unit	126
Changing the beep frequency	127
Changing the startup sound	128
Changing the continuity type	129
Changing the continuity alert type	130
Changing the battery type	131
Resetting the multimeter's Setup options	132
Changing the remote button function	133
Setting the display count	134
Setting the data refresh rate	135
Setting the input impedance	136
Enabling the DC path filter	137
Enabling the AC path filter (for U1282A only)	138

5 Characteristics and Specifications

A Appendix A: Shift Functions Using the Shift Key

B Appendix B: Dual Display Combinations Using the Dual Key

THIS PAGE HAS BEEN INTENTIONALLY LEFT BLANK.

List of Tables

Table 1-1	Battery level indicator	.24
Table 1-2	Hazardous voltage indication table	.27
Table 1-3	Hazardous current indication table	.27
Table 1-4	Power-on options	.32
Table 1-5	Front panel parts	.33
Table 1-6	Rear panel parts	.34
Table 1-7	Rotary switch functions	.35
Table 1-8	Keypad functions	.37
Table 1-9	General annunciators	.40
Table 1-10	Measurement units display	.43
Table 1-11	Analog bar graph display	.44
Table 1-12	Terminal connections for different measuring functions	.46
Table 2-1	Rotary switch positions allowing AC voltage measurements	.51
Table 2-2	Rotary switch positions allowing AC voltage measurements with LPF	.53
Table 2-3	Rotary switch positions allowing DC voltage measurements	.55
Table 2-4	Rotary switch positions allowing AC+DC signal measurements	.57
Table 2-5	Rotary switch positions allowing dBm or dBV measurements	.60
Table 2-6	Rotary switch position allowing resistance measurements	.62
Table 2-7	Rotary switch position allowing continuity tests	.65
Table 2-8	Threshold resistance values	.65
Table 2-9	Rotary switch position allowing diode tests	.68
Table 2-10	Rotary switch position allowing capacitance measurements	.74
Table 2-11	Rotary switch position allowing temperature measurements	.76
Table 2-12	Rotary switch positions allowing current measurements	.80
Table 2-13	Rotary switch positions allowing current measurements in % scale	.84
Table 2-14	% Scale measurement range	.85
Table 2-15	Rotary switch positions allowing frequency measurements	.87
Table 3-1	Data logging maximum capacity	.105
Table 3-2	Event log trigger conditions	.108
Table 4-1	Setup menu key functions	.114
Table 4-2	Setup menu item descriptions	.116
Table A-1	Default and shift functions	.142
Table B-1	Dual display combinations	.144

THIS PAGE HAS BEEN INTENTIONALLY LEFT BLANK.

List of Figures

Figure 1-1	Removing the orange rubber holster	.21
Figure 1-2	Installing the orange rubber holster	.22
Figure 1-3	Start-up display	.25
Figure 1-4	Example of wrong terminal input	.28
Figure 1-5	Input warning display	.29
Figure 1-6	Tilt-stand adjustment and IR-USB cable connection	.29
Figure 1-7	Bluetooth adapter connection	.31
Figure 1-8	Keysight Handheld Meter Logger Software	.31
Figure 1-9	Front panel	.33
Figure 1-10	Rear panel	.34
Figure 1-11	Rotary switch	.35
Figure 1-12	Keypad keys	.36
Figure 1-13	Display screen	.40
Figure 1-14	Connector terminals	.45
Figure 1-15	The location of the button on the Remote Switch Probe	.47
Figure 1-16	Remote Switch Probe connection to the multimeter	.47
Figure 2-1	AC voltage display	.51
Figure 2-2	Measuring AC voltage	.52
Figure 2-3	Low-pass filter	.53
Figure 2-4	Low-pass filter operation	.53
Figure 2-5	AC voltage (with LPF) display	.54
Figure 2-6	DC voltage display	.55
Figure 2-7	Measuring DC voltage	.56
Figure 2-8	AC+DC voltage display	.57
Figure 2-9	AC+DC current display	.58
Figure 2-10	AC+DC voltage (with LPF) display	.59
Figure 2-11	dBm display	.61
Figure 2-12	dBV display	.61
Figure 2-13	Resistance display	.62
Figure 2-14	Measuring resistance	.63
Figure 2-15	Testing for continuity	.67
Figure 2-16	Diode display	.68
Figure 2-17	Open diode display	.69
Figure 2-18	Testing a forward-bias diode	.70
Figure 2-19	Testing a reverse-bias diode	.71
Figure 2-20	Frequency counter mode	.73
Figure 2-21	Capacitance display	.74
Figure 2-22	Measuring capacitance	.75
Figure 2-23	Temperature display	.77
Figure 2-24	Measuring temperature	.78
Figure 2-25	Temperature measurement without ambient compensation	.79
Figure 2-26	DC current display	.81

Figure 2-27	Measuring AC or DC current	83
Figure 2-28	4-20 mA % scale display	84
Figure 2-29	0-20 mA % scale display	85
Figure 2-30	Measuring DC current using the 0-20 mA % scale	86
Figure 2-31	Frequency display	88
Figure 2-32	Frequency, pulse width, and duty cycle measurements	88
Figure 2-33	Pulse width display	90
Figure 2-34	Duty cycle display	91
Figure 2-35	Square wave output display	92
Figure 2-36	Square wave output	93
Figure 3-1	Non-contact AC voltage detector (Vsense) mode	97
Figure 3-2	Null display	98
Figure 3-3	Null operation	99
Figure 3-4	MaxMin display	100
Figure 3-5	Peak display	102
Figure 3-6	Peak hold operation	103
Figure 3-7	Manual log display	106
Figure 3-8	Interval log display	107
Figure 3-9	Event log display	108
Figure 3-10	Export log display (TrigHold mode)	109
Figure 3-11	Export log display (AutoHold mode)	110
Figure 3-12	View display	111
Figure 3-13	Empty view display	111
Figure 4-1	AHoLd display	119
Figure 4-2	tiME display - Smooth	120
Figure 4-3	AoFF display	121
Figure 4-4	bLit display	121
Figure 4-5	tYPE display - data logging	122
Figure 4-6	tiME display - data logging	123
Figure 4-7	dbrEF display	124
Figure 4-8	CoUPL display	125
Figure 4-9	Unit display	126
Figure 4-10	bEEP display	127
Figure 4-11	SoUnd display	128
Figure 4-12	tYPE display - continuity	129
Figure 4-13	Horn display	130
Figure 4-14	bAt display	131
Figure 4-15	rESet display	132
Figure 4-16	rEM-b display	133
Figure 4-17	diSP display	134
Figure 4-18	d-UPd display	135
Figure 4-19	inPUT display	136
Figure 4-20	LPF display - DC	137
Figure 4-21	LPF display - AC	138

Keysight U1281A/U1282A Handheld Digital Multimeter User's Guide

1 Introduction

About This Manual	20
Documentation map	20
Preparing Your Multimeter	21
Check the shipment	21
Removing the holster	21
Installing the holster	22
Installing the batteries	22
Turn on your multimeter	25
Automatic power-off	25
Enabling the backlight	25
Selecting the range	26
Alerts and warnings during measurement	27
Adjusting the tilt stand	29
Remote communication	30
Power-on options	32
Your Multimeter in Brief	33
Overview	33
Rotary switch	35
Keypad	36
Display screen	40
Input terminals	45
Using the Remote Switch Probe	47
Cleaning Your Multimeter	48

This chapter lists the package contents for this multimeter, and teaches you how to set up your multimeter for the first time. An introduction to all the features of the multimeter is also given. This introduction does not cover all of the capabilities of the multimeter but gives basic examples to help you perform basic operations on your multimeter.

About This Manual

Documentation map

The following manuals and software related to the U1281A/U1282A Handheld Digital Multimeter are available for download. Please visit our website at <http://www.keysight.com/find/hhTechLib> for the latest version.

Check the manual edition on the first page of each manual.

User's Guide. This manual.

Quick Start Guide. Printed copy for outdoor use, included with shipment.

Service Guide. Downloadable from <http://www.keysight.com/find/hhTechLib>

Keysight Handheld Meter Logger Software.

Downloadable from <http://www.keysight.com/find/hhmeterlogger>

Safety notes

The following safety notes are used throughout this manual. More pertinent safety notes for using this product are located under the **Safety Symbols** section.

CAUTION

Caution denotes a hazard. It calls attention to a procedure that, if not correctly performed or adhered to, could result in damage to or destruction of the product. Do not proceed beyond a caution notice until the indicated conditions are fully understood and met.

WARNING

Warning denotes a hazard. It calls attention to a procedure which, if not correctly performed or adhered to, could result in injury or loss of life. Do not proceed beyond a warning note until the indicated conditions are fully understood and met.

Preparing Your Multimeter

Check the shipment

When you receive your multimeter, check the shipment according to the following procedure.

- 1 Inspect the shipping container for damage. Signs of damage may include a dented or torn shipping container or cushioning material that indicates signs of unusual stress or compacting. Save the packaging material in case the multimeter needs to be returned.
- 2 Carefully remove the contents from the shipping container, and verify that the standard accessories and your ordered options are included in the shipment according to the Included Accessories list located at the side of the box.
- 3 For any question or problems, refer to the Keysight contact numbers on the back of this manual.

Removing the holster

- 1 Push the top of the orange rubber holster outward and backward.
- 2 Push the multimeter from the back until the orange rubber holster is completely detached from the multimeter.



Figure 1-1 Removing the orange rubber holster

Installing the holster

- 1 Insert the multimeter into the lower part of the orange rubber holster.
- 2 Press the top part of the multimeter to secure the orange rubber holster.

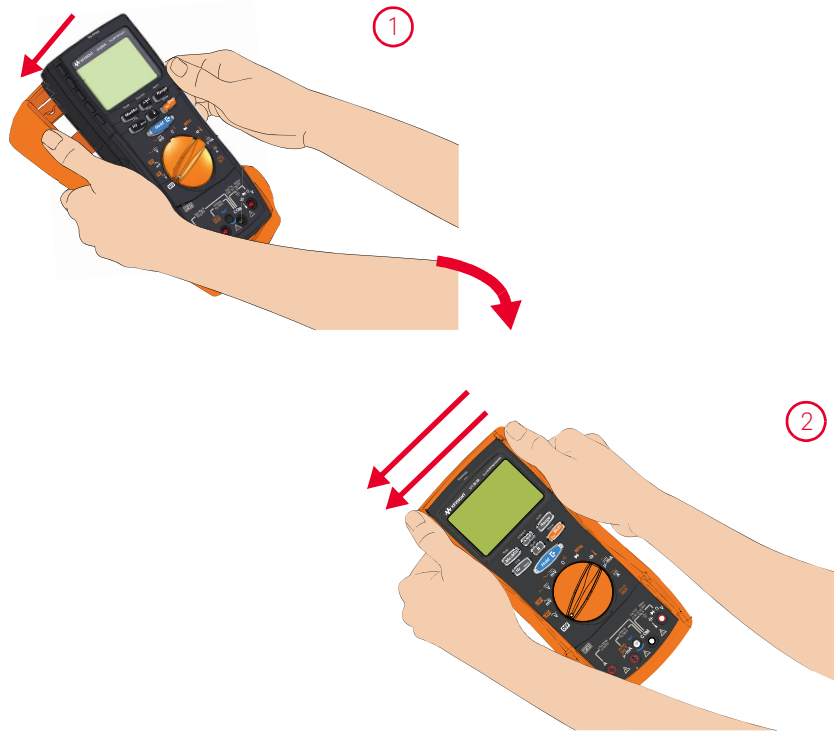

Figure 1-2 Installing the orange rubber holster

Installing the batteries

Your multimeter is powered by four 1.5 V AA batteries (included with the shipment). When you receive your multimeter, the batteries are not installed.

Use the following procedure to install the batteries.

CAUTION

Before you proceed with the battery installation, remove all cable connections to the terminals and ensure that the rotary switch is at the OFF position. Use only the battery type specified in the datasheet.

- 1 Remove the orange rubber holster. Push from a top corner and stretch the orange rubber holster off the multimeter.
- 2 Loosen the two screws with a suitable Phillips screwdriver as shown on the right.

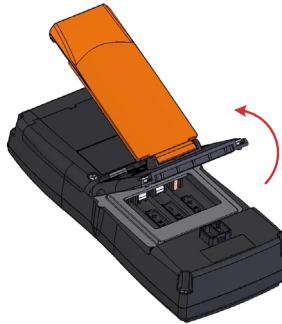
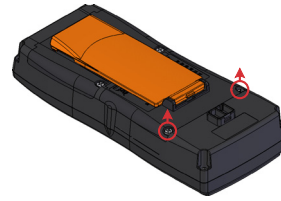

- 3 Lift and remove the battery cover as shown on the left.

- 4 Lift the inner rubber cover to access the battery compartment.
- 5 Observe the proper battery polarity. The terminal ends of each battery are indicated inside the battery compartment. Insert four 1.5 V AA batteries.

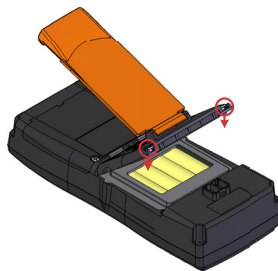
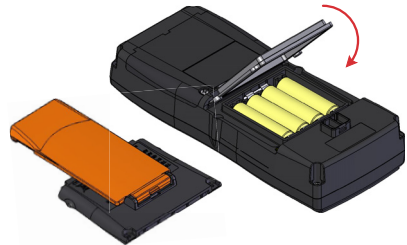





- 6 Ensure that the inner rubber cover is positioned properly.
- 7 Replace the battery cover back in its original position and tighten the screws.
- 8 Finally fit the orange rubber holster back on the multimeter.

The battery level indicator at the lower left-hand corner of the display indicates the relative condition of the batteries. To ensure that the multimeter's battery level indicator is

accurate, please select your battery type in the Setup menu (refer to “**Changing the battery type**” on page 131 for more information). When the battery voltage falls below 3.8 V, the multimeter will shut down automatically regardless of the Auto Power-Off setting.

Table 1-1 describes the various battery levels the indicator represents.

Table 1-1 Battery level indicator

Indication	Battery capacity	
	Primary	Secondary
	4.2 V ~ 6 V	4.5 V ~ 5.4 V
	Full capacity	
	2/3 capacity	
	1/3 capacity	
 (<i>Flashing periodically</i>)	Almost empty	

WARNING

To avoid false readings, which could lead to possible electric shock or personal injury, replace the battery as soon as the low battery indicator appears. Do not discharge the battery by shorting the battery or reverse the battery polarity in any of the subjects.

CAUTION

To avoid damage from battery leakage:

- Always remove dead batteries immediately.
- Always remove the batteries and store them separately if the multimeter is not going to be used for a long period.

Turn on your multimeter

To power ON your multimeter, turn the rotary switch to any position other than **OFF**. The model number of your multimeter and its firmware version are shown on the primary display and secondary display respectively.

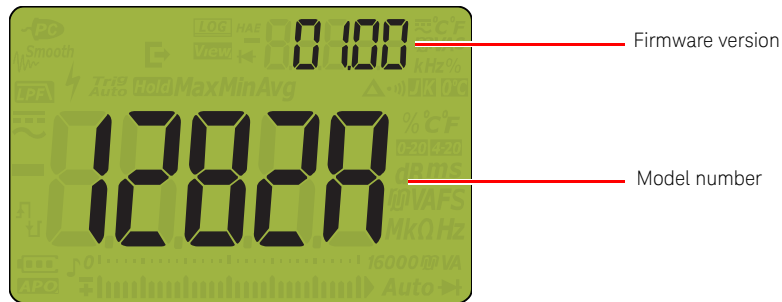

Figure 1-3 Start-up display

To power OFF your multimeter, turn the rotary switch to the **OFF** position.

Automatic power-off

Your multimeter automatically turns off if the following actions do not take place within the set duration (refer to “**Changing the Auto Power-Off and backlight timeouts**” on page 121 for more information):

- The rotary switch is moved.
- A key is pressed.
- The multimeter is in MaxMin mode (see “**Capturing Maximum and Minimum Values (MaxMin)**” on page 100).
- The multimeter is in Peak Hold mode (see “**Capturing Peak Values (Peak)**” on page 102).

The following actions will turn the multimeter back on after it is powered off automatically:

- Pressing any key on the keypad.
- Restarting the multimeter by turning the rotary knob to **OFF**, then turning it to a desired measurement function.
- Turning the rotary knob to another measurement function.

Enabling the backlight

If viewing the display becomes difficult in low-light conditions, press  to activate the backlight for the LCD and the keypad.

To conserve battery life, a user-adjustable timeout controls how long the backlight stays on. The default timeout is 15 seconds (refer to “**Changing the Auto Power-Off and backlight timeouts**” on page 121 for more information).

Selecting the range

The multimeter's selected range is always displayed above the right-hand end of the bar graph. Pressing  switches the multimeter between manual and autoranging. It also scrolls through the available multimeter ranges when manual ranging is enabled.

Autoranging is convenient because the multimeter automatically selects an appropriate range for sensing and displaying each measurement. However, manual ranging results in better performance since the multimeter does not have to determine which range to use for each measurement.

NOTE

The range is fixed for diode tests and temperature measurements.

In autorange, the multimeter selects the lowest range to display the highest available precision (resolution) for the input signal. If manual range is already enabled, press  for more than 1 second to enter the autoranging mode.

If autoranging is enabled, press  to enter the manual range mode.

Each additional press of  sets the multimeter to the next higher range, unless it is already in the highest range, at which point the range switches to the lowest range.

Alerts and warnings during measurement

Hazardous voltage indication

The multimeter will display the hazardous voltage () symbol as an early precaution when the measured voltage is equal to or greater than 30 V or when OL occurs. The following table shows the voltage measurement modes affected:

Table 1-2 Hazardous voltage indication table

Measurement	DC		AC
V (mV)	$\geq +30$ V or +OL	≤ -30 V or -OL	≥ 30 V or OL

Hazardous current indication

The multimeter will display the hazardous current () symbol as an early precaution when the measured current reaches the maximum fuse rating or when OL occurs. If your measuring current is > 10 A ~ 19.999 A, you will need to lower the current within a 30-second time limitation to avoid blowing the multimeter's fuse. The following table shows the current measurement modes affected:

Table 1-3 Hazardous current indication table

Measurement	DC		AC
A	$\geq +11$ A or +OL	≤ -11 A or -OL	≥ 11 A or OL
μ A/mA	≥ 440 mA or +OL	≤ -440 mA or -OL	≥ 440 mA or OL

Input warning

CAUTION

To avoid circuit damage and possibly blowing the multimeter's current fuse, do not place the probes across (in parallel with) a powered circuit when a lead is plugged into a current terminal. This causes a short circuit because the resistance through the multimeter's current terminals is very low.

The red LED on the multimeter turns on and the multimeter emits a continuous beep and displays **R-Err** or **MAErr** in the secondary display when the test lead is inserted into the **A** or **μ mA** input terminal but the rotary switch is not set to the correct current position. The sound will continue and the red LED will remain lit until the test leads are removed from the multimeter. If the test leads are not removed, the sound will stop after 5 seconds.



Figure 1-4 Example of wrong terminal input

This warning is intended to stop you from attempting to measure voltage, continuity, resistance, capacitance, diode, or temperature values when the leads are plugged into a current terminal.

The red LED on the multimeter turns on briefly and the multimeter emits a brief beep and displays **LEAd** in the secondary display when the rotary switch is set to the μmA or A current position but no test leads are inserted into the **A** or μmA input.



Figure 1-5 Input warning display

Adjusting the tilt stand

To adjust the multimeter to a 60° standing position, pull the tilt-stand outward to its maximum reach.

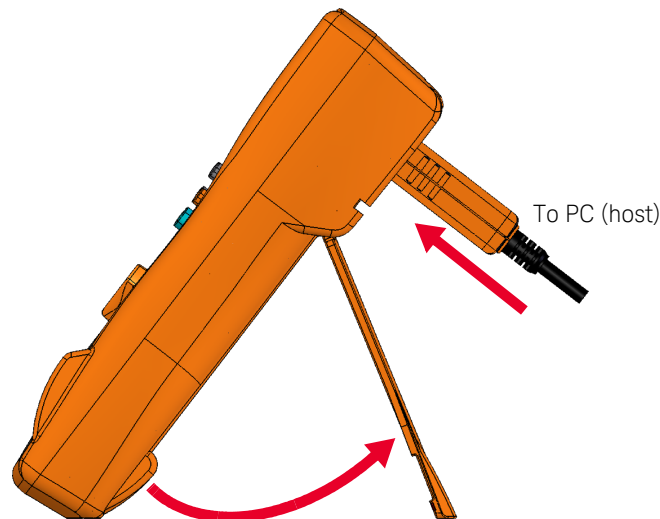

Figure 1-6 Tilt-stand adjustment and IR-USB cable connection

Remote communication

You can communicate remotely with the multimeter from your PC via an IR-USB connection (see **Using an IR-USB cable**) or an IR-*Bluetooth* connection (see **Using a Bluetooth adapter**).

When configuring the IR interface of the multimeter, use the following settings as the default:

- Baud rate: 9600 bits per second
- Parity bit: None
- Data bits: 8 data bits
- Number of Stop bits: 1 bit

You can use any of the following software to communicate with the multimeter:

- Keysight Handheld Meter Logger (for Windows PC)
- Keysight Mobile Meter (for Android or iOS devices)
- Keysight Mobile Logger (for Android or iOS devices)

Using an IR-USB cable

The U1173B IR-USB cable (included with your shipment) can be used to connect your multimeter to your PC via the IR communication link (IR communication port, located at the rear panel). Ensure that the Keysight logo on the IR-USB cable connected to the multimeter is facing up. Firmly push the IR head into the multimeter's IR communication port until it snaps into place (see **Figure 1-6**).

Using a *Bluetooth* adapter

The U1117A Infrared (IR)-to-*Bluetooth*[®] adapter (purchased separately) allows you to connect the multimeter wirelessly to any Windows PC, Android device, or iOS device.

The U1117A is compatible with the following application or software:

- Keysight Handheld Meter Logger (for Windows PC)
- Keysight Mobile Meter (for Android or iOS devices)
- Keysight Mobile Logger (for Android or iOS devices)

Snap the optic side of the U1117A to the multimeter's IR communication port (see **Figure 1-7**).

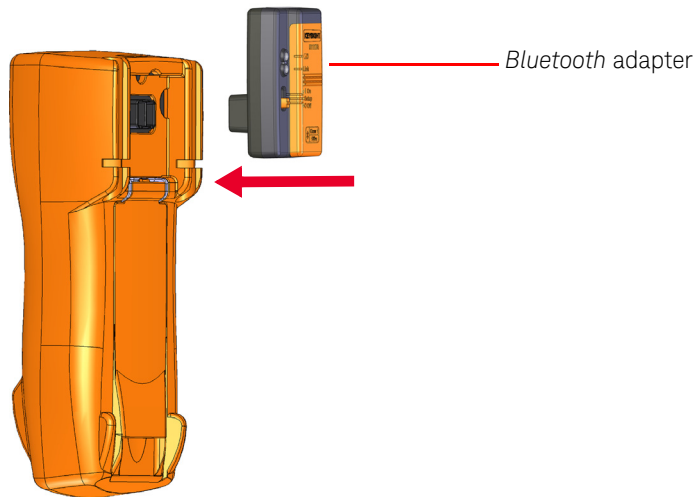

Figure 1-7 Bluetooth adapter connection

Refer to the *Keysight U117A IR-to-Bluetooth Adapter Operating Instructions* (download from <http://www.keysight.com/find/U117A>) for more information on how to set up the U117A with a Windows PC, Android device, or iOS device.

Using the Handheld Meter Logger Software

You can use the IR communication link and the Keysight Handheld Meter Logger Software to control your multimeter remotely, perform data logging operations, and transfer the contents of your multimeter's memory to a PC. Refer to the *Keysight Handheld Meter Logger Software Help File* for more information on the IR communication link and the Keysight Handheld Meter Logger Software.

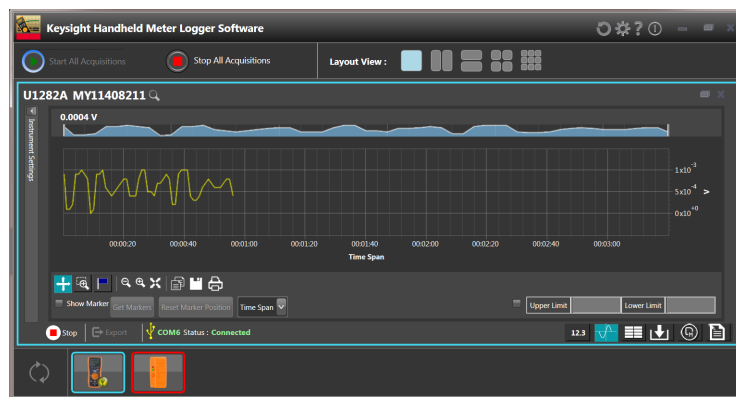





Figure 1-8 Keysight Handheld Meter Logger Software

The Keysight Handheld Meter Logger Software and its supporting documents are available for download from <http://www.keysight.com/find/hhmeterlogger>.

Power-on options

Some options can be selected only while you turn the multimeter on. These power-on options are listed in the table below. To select a power-on option, press and hold the specified key while turning the rotary switch from **OFF** to any other position. Power-on options remain selected until the multimeter is turned off.

Table 1-4 Power-on options

Key	Description
	LCD test. All annunciators are displayed in the LCD. Press any key to exit this mode.
	Simulates the Auto Power-Off (APO) mode. Press any key to turn the multimeter back on and resume normal operation.
	Enters the Setup mode. For more information, refer to Chapter 4 , "Using the Setup Menu".
	Triggers the exporting of data via the multimeter's optical communication port. The reading on the primary display is exported, according to the display update rate. Restart the multimeter to resume normal operation.

Your Multimeter in Brief

Overview

Front panel

The front panel parts of your multimeter are described in this section. Click the respective “Learn more” pages for more information on each part.

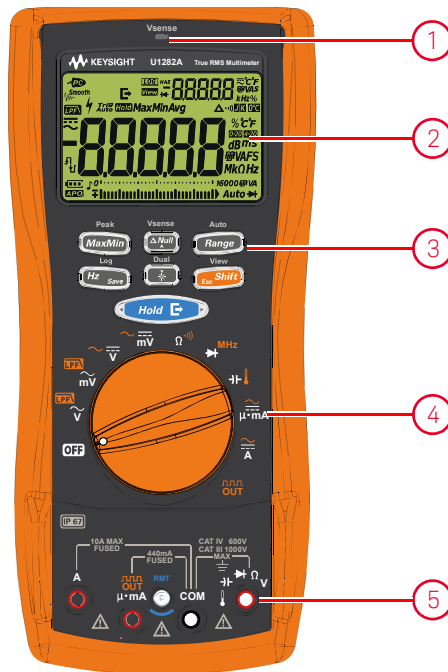

Figure 1-9 Front panel

Table 1-5 Front panel parts

Legend	Description	Learn more on:
1	Vsense detector	page 96
2	Display screen	page 40
3	Keypad	page 36
4	Rotary switch	page 35
5	Terminals	page 45

Rear panel

The rear panel parts of your multimeter are described in this section. Click the respective “Learn more” pages for more information on each part.

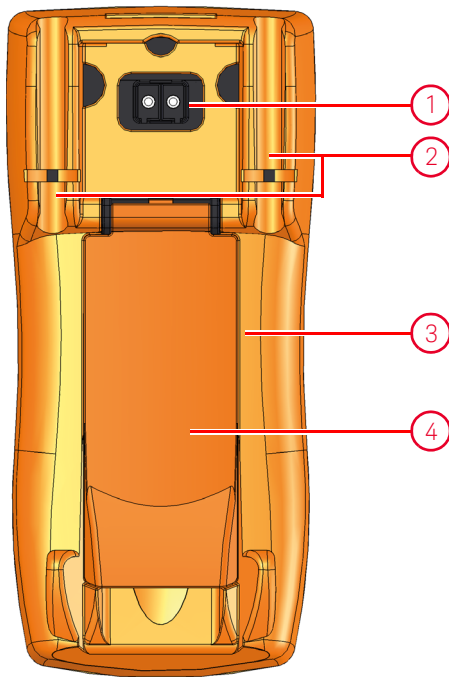

Figure 1-10 Rear panel



Table 1-6 Rear panel parts

Legend	Description	Learn more on:
1	IR communication port	-
2	Test probe holders	-
3	Battery and fuse access cover	page 22
4	Tilt stand	page 29

Rotary switch

The measurement functions for each rotary switch position are described in **Table 1-7**. Turning the rotary switch changes the measurement function and resets all other measurement options.

NOTE

Some rotary switch positions have a shifted function printed in orange. Press  to switch between the shifted and regular function. See **page 37** for more information on the  key or **page 142** for more information on shifted functions.

WARNING

Remove the test leads from the measuring source or target before changing the rotary switch position.

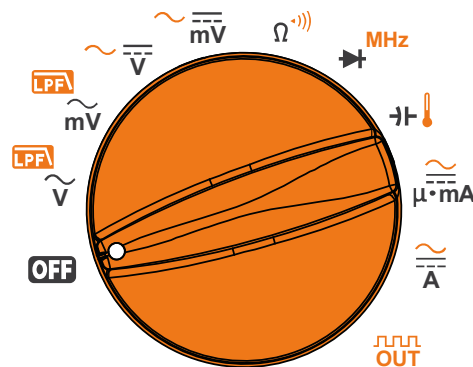

Figure 1-11 Rotary switch

Each position of the rotary switch (shown in **Figure 1-11**) is described in **Table 1-7**.

Table 1-7 Rotary switch functions











Legend	Description	Learn more on:
	Off	page 25
	AC voltage measurement with Low-Pass Filter	page 51
	AC voltage measurement (up to millivolts) with Low-Pass Filter	

Table 1-7 Rotary switch functions (continued)

Legend	Description	Learn more on:
	AC, DC, or AC+DC voltage measurement	page 55
	AC, DC, or AC+DC voltage measurement (up to millivolts)	
	Resistance measurement or Continuity test	page 62 and page 65
	Diode test or Frequency counter	page 68 and page 72
	Capacitance measurement or Temperature measurement	page 74 and page 76
	AC, DC, or AC+DC current measurement (up to milliamperes)	page 80
	AC, DC, or AC+DC current measurement	
	Square wave mode	page 92

Keypad

The operation of each key is explained below. Pressing a key enables a function, displays a related symbol, and emits a beep. Turning the rotary switch to another position resets the current operation of the key. Click the respective “Learn more” pages for more information on each function.

**Figure 1-12** Keypad keys

Table 1-8 Keypad functions







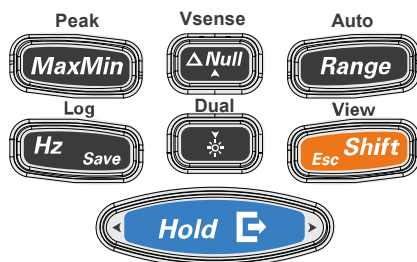







Legend	Function when pressed for:		Learn more on:
	Less than 1 second	More than 1 second	
	<p>Sets the Null/Relative mode.</p> <ul style="list-style-type: none"> The displayed value is saved as a reference to be subtracted from subsequent measurements. While in Null mode, press  again to view the stored reference value that has been saved. The display will return to normal after 3 seconds. Pressing  while the relative value is being displayed will cancel the Null mode. 	<p>Enables and disables the non-contact voltage presence indicator (Vsense).</p> <ul style="list-style-type: none"> Press  to toggle between low sensitivity (Lo.SE) or high sensitivity (Hi.SE) Press  for more than 1 second to disable Vsense. 	<p>page 96 and page 98</p>
	<p>Starts the MaxMinAvg recording.</p> <ul style="list-style-type: none"> Press  again to scroll through maximum (Max), minimum (Min), average (Avg), and present (MaxMinAvg) readings. Press  for more than 1 second to exit this mode. 	<ul style="list-style-type: none"> Stops the MaxMinAvg recording. Starts and stops the Peak recording. Press  again to switch between the maximum (HoldMax) and minimum (HoldMin) peak readings. Press  for more than 1 second to exit this mode. 	<p>page 100 and page 102</p>
	<ul style="list-style-type: none"> Freezes the present reading in the display (Trig Hold mode). <ul style="list-style-type: none"> In TrigHold mode, press  to manually trigger the holding of the next measured value. Automatically freezes the present reading, and updates the values once the reading is stable (Auto Hold mode). Exits the Auto Hold mode. Stores a record of the measured signal and exports it via the multimeter's optical communication port. 	<p>Exits the Trig Hold mode.</p>	<p>page 104</p>
	<p>Turns the backlight on or off.</p>	<p>Activates dual display mode (if supported by the measurement).</p> <p>Exits the dual display mode.</p> <ul style="list-style-type: none"> Press  for more than 1 second to toggle between the available dual display modes for supported measurement functions. 	<p>page 25</p>

Table 1-8 Keypad functions (continued)

























Legend	Function when pressed for:		Learn more on:
	Less than 1 second	More than 1 second	
	<p>Enables the frequency test mode for current or voltage measurements.</p> <ul style="list-style-type: none"> - Press  to scroll through the frequency (Hz), duty cycle (%), and pulse width (ms) measurements. - In duty cycle and pulse width measurements, press  for more than 1 second to switch between the positive- or negative-edge trigger. - Press  to scroll back to the frequency measurement mode, and hold  for more than 1 second to exit the frequency measurement function. 	<p>Starts and stops the Data Logging.</p> <ul style="list-style-type: none"> - If data logging is set as HRnd (manual data logging), pressing  for more than 1 second will log the present value and function into the memory. The display will return to normal after a short while (≈ 1 second). To manually log another reading, press  again for more than 1 second. - If data logging is set as Auto (interval data logging), pressing  for more than 1 second will enter the interval data logging mode, where data is logged at the interval defined in the multimeter's Setup. - If data logging is set as Trig (event data logging), pressing  for more than 1 second will enter the event data logging mode, where data is logged each time a triggering condition is satisfied. - Press  for more than 1 second to exit the interval or event data logging mode. 	<p>page 87 and page 105</p>

Table 1-8 Keypad functions (continued)

Legend	Function when pressed for:		Learn more on:
	Less than 1 second	More than 1 second	
	<ul style="list-style-type: none"> - Sets a manual range and disables autoranging. - Press  again to scroll through each available measurement range. - Enables or disables the temperature measurement without ambient compensation mode. - Changes the measurement range and restarts the maximum and minimum peak measurements. 	<ul style="list-style-type: none"> - Enables autoranging. - During temperature measurements, pressing  changes the temperature measurement unit between Celsius (°C) and Fahrenheit (°F) 	page 26
	<p>Switches between the regular and <i>shifted</i> measurement function (icon printed in orange above the rotary switch position – if available).</p> <ul style="list-style-type: none"> - Press  again to switch back to the regular measurement function. - Press  while turning the rotary switch from the OFF position to access the Setup menu. 	<p>Enters the Log Review menu.</p> <ul style="list-style-type: none"> - Press  again to scroll through the previously recorded export (E), manual (H), event (E), or interval (A) logging data. - Press  or  on  to view the first or last logged entry respectively. - Press  or  to scroll through the logged data. - Press  to delete the last stored entry for the selected logging mode. - Press and hold  for more than 1 second to clear all the logged data for the selected logging mode. - Press  for more than 1 second to sanitize all log memories when all the logging modes have been cleared of all entries. - Press  for more than 1 second to exit this mode. 	page 35 and page 111

Display screen

The display annunciators of your multimeter are described in this section. See also “**Measurement units**” on page 43 for a list of available measurement signs and notations and “**Analog bar graph**” on page 44 for a tutorial on the analog bar graph located at the bottom of your display screen.

General display annunciators

The general display annunciators of your multimeter are described in the table below. Click the respective “Learn more” pages for more information on each annunciator.

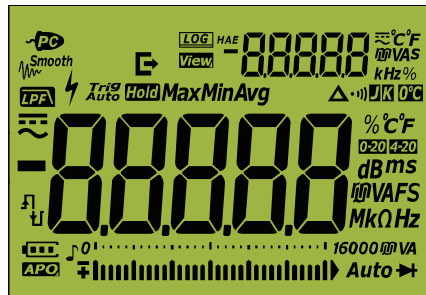

Figure 1-13 Display screen

Table 1-9 General annunciators









Legend	Description	Learn more on:
	Remote control enabled	-
	Data logging in progress	page 105
<i>HAE</i>	Data logging type	page 105
	Data log export in progress	page 105
	View mode for reviewing previously logged data	page 111
	Secondary measurement display	-
	AC, DC, and AC+DC indication for secondary display	page 57 and page 87
	Measuring units for the secondary display	page 43
	Low-pass filter enabled for AC measurement Filter enabled for DC measurement	page 57 and page 87

Table 1-9 General annunciators (continued)













Legend	Description	Learn more on:
	<ul style="list-style-type: none"> - Hazardous voltage sign for measuring voltage ≥ 30 V or overload - Hazardous current sign for measuring current that exceeds the fuse rating 	page 27
Trig Hold	Trigger hold enabled	page 104
Auto Hold	Auto hold enabled	
HoldMax	Peak hold (maximum value) enabled	page 102
HoldMin	Peak hold (minimum value) enabled	
Max	Maximum reading shown on primary display	
Min	Minimum reading shown on primary display	page 100
Avg	Averaged reading shown on primary display	
MaxMinAvg	Present reading shown on primary display	
	Relative (Null) enabled	page 96
	Audible continuity test selected	page 65
	Temperature measurement without ambient compensation selected	
	J-type thermocouple selected	
	K-type thermocouple selected	
	4-20 mA % scale mode selected	page 84
	0-20 mA % scale mode selected	
	DC (direct current)	page 53 and page 76
	AC (alternating current)	page 51 and page 76
	<ul style="list-style-type: none"> - Capacitor is charging (during capacitance measurement) - Positive slope for pulse width (ms) and duty cycle (%) measurements 	page 74 and page 87
	<ul style="list-style-type: none"> - Capacitor is discharging (during capacitance measurement) - Negative slope for pulse width (ms) and duty cycle (%) measurements 	

Table 1-9 General annunciators (continued)

Legend	Description	Learn more on:
	Primary measurement display	-
	Measuring units for the primary display	page 43
	Measurement range selected	page 26
	Battery capacity indication	page 24
	APO (Auto Power-Off) enabled	page 25
	Tone enabled	-
	Analog bar graph	page 44
	Autoranging enabled	page 26
	Diode test selected	page 68
	Smooth mode enabled	page 29
	Overload (the reading exceeds the display range)	-

Measurement units

The available signs and notations for each measurement function in your multimeter are described in **Table 1-10**. The units listed below are applicable to the primary display and secondary display measurements of your multimeter.

Table 1-10 Measurement units display

Sign/Notation	Description
M	Mega 1E+06 (1000000)
k	kilo 1E+03 (1000)
n	nano 1E-09 (0.000000001)
μ	micro 1E-06 (0.000001)
m	milli 1E-03 (0.001)
dBm	Decibel unit relative to 1 mW
dBV	Decibel unit relative to 1 V
mV, V	Voltage units for voltage measurement
A, mA, μA	Ampere units for current measurement
nF, μF, mF	Farad units for capacitance measurement
Ω, kΩ, MΩ	Ohm units for resistance measurement
MHz, kHz, Hz	Hertz units for frequency measurement
nS	Nano-Siemens unit for conductance measurement
ms	Millisecond, unit for pulse width measurement
%	Percent, unit for duty cycle measurement
% 0-20	Percent, unit for the scale proportional to DC 0~20 mA
% 4-20	Percent, unit for the scale proportional to DC 4~20 mA
°C	Degree Celsius, unit for temperature measurement
°F	Degree Fahrenheit, unit for temperature measurement
s	Seconds, unit for Peak and Recording mode elapsed time

Analog bar graph





The analog bar emulates the needle on an analog multimeter, without displaying the overshoot. When measuring peak or null adjustments and viewing fast-changing inputs, the bar graph provides a useful indication because it has a faster updating rate^[1] to cater to fast-response applications.

For frequency, duty cycle, pulse width, 4-20 mA % scale, 0-20 mA % scale, dBm, dBV, and temperature measurements, the bar graph does not represent the primary display value.

For example, when frequency, duty cycle, or pulse width is displayed on the primary display during voltage or current measurement, the bar graph represents the voltage or current value (not the frequency, duty cycle, or pulse width value). Another example is when the 4-20 mA % scale or 0-20 mA % scale is displayed on the primary display, the bar graph represents the current value and not the percentage value.

The “+” or “-” sign indicates whether the measured or calculated value is positive or negative. Each segment represents 200 or 33.3 counts depending on the range indicated on the peak bar graph.

Table 1-11 Analog bar graph display

Range	Counts/Segments	Used for the function
		
	200	V, A, Ω, \rightarrow
		
	33.3	V, A, Ω, \rightarrow , \leftarrow

An unstable bar graph and unmatched primary display when measuring DC voltage usually means the presence of AC voltages in the circuit if the DC Filter is disabled in the Setup mode.

[1] The analog bar graph measurement rate is approximately 30 times/second for DC voltage, current, and resistance measurements.

Input terminals

The terminal connections for the different measurement functions of your multimeter are described in **Table 1-12**. Observe the rotary switch position of your multimeter before connecting the test leads to the connector terminals.

WARNING

Ensure that the terminal connections are correct for that particular measurement function before starting any measurement.

CAUTION

To avoid damaging this multimeter, do not exceed the rated input limit.

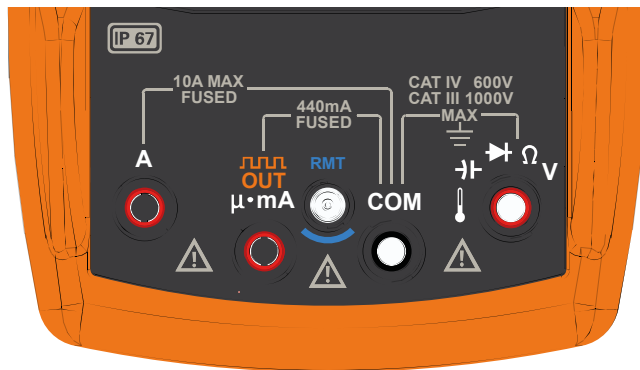

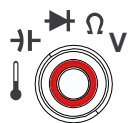











Figure 1-14 Connector terminals

Table 1-12 Terminal connections for different measuring functions

Rotary switch position	Input terminals	Overload protection
		1000 Vrms
	 	1000 Vrms for short circuit < 0.3 A
	 	11 A/1000 V, fast-acting fuse
	 	440 mA/1000 V, fast-acting fuse
		
Remote probe terminal (see "Using the Remote Switch Probe" on page 47 for more information)		

Using the Remote Switch Probe

The Remote Switch Probe (purchased separately) enables the multimeter to be controlled remotely from the button on the Remote Switch Probe. By default the button on the Remote Switch Probe emulates the  button on the multimeter.

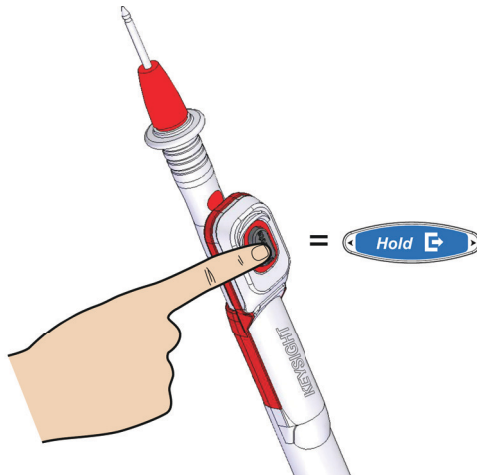

Figure 1-15 The location of the button on the Remote Switch Probe

Connect the Remote Switch Probe to the multimeter as shown below.

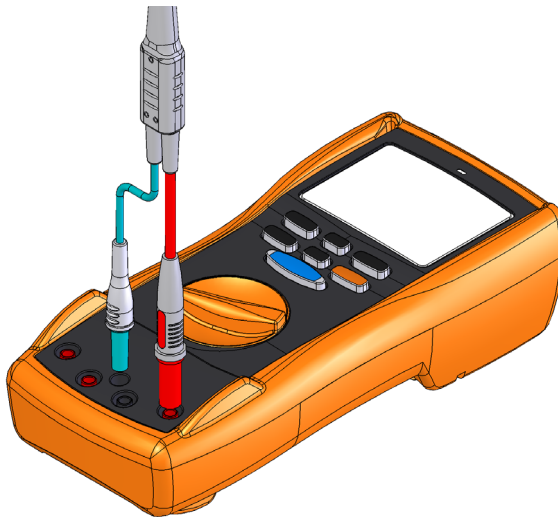

Figure 1-16 Remote Switch Probe connection to the multimeter

To change the default button operation, see “**Changing the remote button function**” on page [133](#).

Cleaning Your Multimeter

WARNING

To avoid electrical shock or damage to the multimeter, ensure that the insides of the casing stay dry at all times.

Dirt or moisture in the terminals can distort readings. Follow the steps below to clean your multimeter.

- 1** Turn the multimeter off and remove the test leads.
- 2** Turn the multimeter over and shake out any dirt that may have accumulated in the terminals.

Wipe the case with a damp cloth and mild detergent – do not use abrasives or solvents. Wipe the contacts in each terminal with a clean swab dipped in alcohol.

Keysight U1281A/U1282A
Handheld Digital Multimeter
User's Guide

2 Making Measurements

Crest Factor	50
Measuring AC Voltage	51
Using the LPF Function for AC measurements (for U1282A only)	53
Measuring DC Voltage	55
Measuring AC and DC Signals	57
Using the LPF (Low Pass Filter) Function for AC+DC measurements	59
Making dB Measurements	60
Measuring Resistance	62
Measuring conductance	64
Testing for Continuity	65
Testing Diodes	68
Frequency Counter (for U1282A only)	72
Measuring Capacitance	74
Measuring Temperature	76
Temperature measurement without ambient compensation	79
Measuring AC or DC Current	80
% Scale of 4-20 mA or 0-20 mA	84
Measuring Frequency	87
Measuring pulse width	90
Measuring duty cycle	91
Square Wave Output	92

The following sections describe how to take measurements with your multimeter.

Crest Factor

The crest factor may be determined by using this formula:

$$\text{Crest factor} = \frac{\text{Peak value}}{\text{True rms value}}$$

You may refer to “**Capturing Peak Values (Peak)**” on page 102 on how to obtain the peak values.

The crest factor may be up to 3.0 at full-scale except for the 600 V and the 1000 V range where it is at 2.5 and 1.5 respectively, as shown in the table below:

Voltage range	Crest factor	Maximum input (V_{peak})
60 mV	3.0	+/- 180 mV
600 mV	3.0	+/- 1800 mV
6 V	3.0	+/- 18 V
60 V	3.0	+/- 180 V
600 V	2.5	+/- 1500 V
1000 V	1.5	+/- 1500 V







WARNING

Exceeding the crest factor limit may result in an incorrect or a lower reading. Do not exceed the crest factor limit to avoid instrument damage and the risk of electric shock.

Measuring AC Voltage

Set up your multimeter to measure AC voltage as shown in **Figure 2-2**. Probe the test points and read the display.

Table 2-1 Rotary switch positions allowing AC voltage measurements

Legend	Default function	Function when  is pressed
 	AC V	AC V with Low-Pass Filter (LPF) (for U1282A only)
 	AC mV	AC mV with Low-Pass Filter (LPF) (for U1282A only)
	DC V	Scrolls between - AC V - AC+DC V, or - DC V
	DC mV	Scrolls between - AC mV - AC+DC mV, or - DC mV

NOTE



AC voltage measurements measured with this multimeter are returned as:

- True rms (root mean square) readings. These readings are accurate for sinusoidal waves and other waveforms with no DC offset, such as square waves, triangle waves, and staircase waves.



Figure 2-1 AC voltage display

NOTE

- Press and hold  for more than 1 second to scroll through the available dual display combinations. (Refer to “**Appendix B: Dual Display Combinations Using the Dual Key**” on page 143 for more information)
- Press  to enable the frequency test mode for voltage measurements. See “**Measuring Frequency**” on page 87 to learn more.

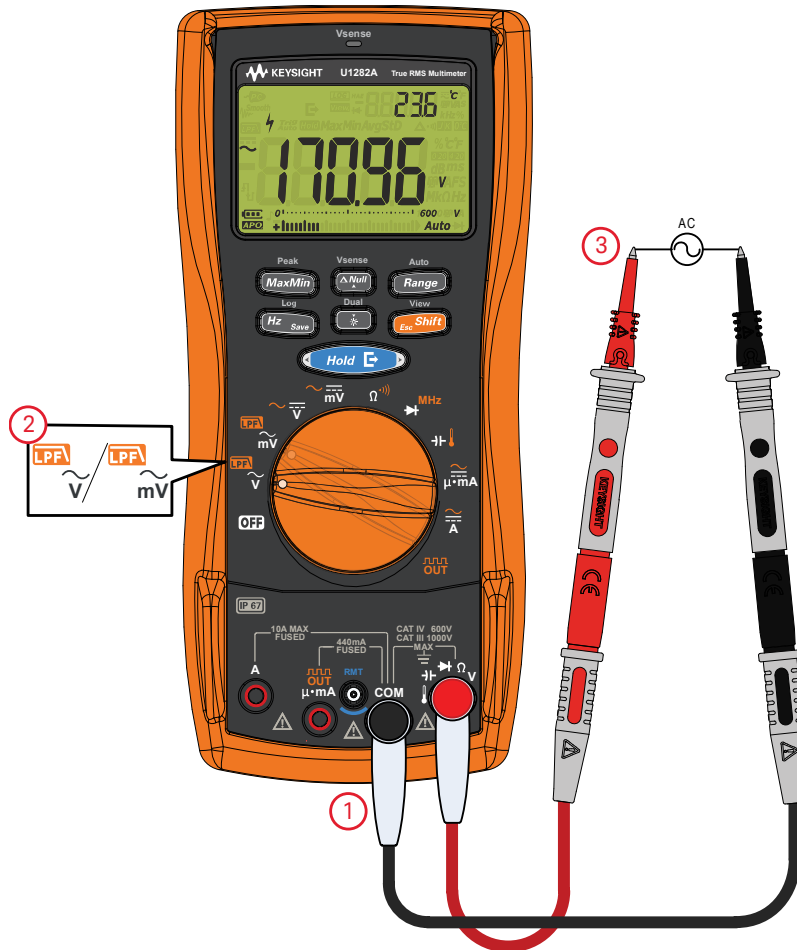

Figure 2-2 Measuring AC voltage



Using the LPF Function for AC measurements (for U1282A only)

WARNING

- To avoid possible electric shock or personal injury, do not use the LPF option to verify the presence of hazardous AC voltages. AC voltage values greater than what are indicated may be present when the LPF is enabled.
- First, make an AC voltage measurement without LPF to detect the possible presence of hazardous voltages. Then, enable the LPF if required for measurement stability and response speed.

Your multimeter is equipped with an AC LPF (low-pass filter) to help reduce unwanted electronic noise when measuring AC voltage or AC frequency. The LPF can improve measurement performance on composite sine waves that are typically generated by inverters and variable frequency drives.

Table 2-2 Rotary switch positions allowing AC voltage measurements with LPF

Legend	Default function	Function when  is pressed
	AC V	AC V with LPF
	AC mV	AC mV with LPF

Set up your multimeter to measure AC voltage as shown in **Figure 2-2**. Press  to enable the LPF. Your multimeter continues measuring in the chosen AC mode, but now the signal diverts through a filter that blocks voltages above 1 kHz (refer to **Figure 2-3**), as shown in **Figure 2-4**.

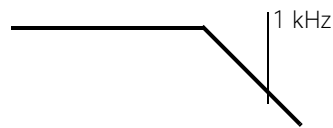

Figure 2-3 Low-pass filter



Figure 2-4 Low-pass filter operation

Probe the test points and read the display.





Figure 2-5 AC voltage (with LPF) display

Measuring DC Voltage

Set up your multimeter to measure DC voltage as shown in **Figure 2-7**. Probe the test points and read the display.

Table 2-3 Rotary switch positions allowing DC voltage measurements

Legend	Default function	Function when  is pressed
	DC V	Scrolls between - AC V - AC+DC V, or - DC V
	DC mV	Scrolls between - AC mV - AC+DC mV, or - DC mV

NOTE

This multimeter displays DC voltage values as well as their polarity. Negative DC voltages will return a negative sign on the left of the display.





Figure 2-6 DC voltage display

CAUTION

- If the signal includes an AC component and the peak value exceeds the measurement range, you will need to lock the range that is greater than the voltage peak. Use the maximum range of 1000 V to check the signal condition, and manually select a suitable range for the signal.
- As the DC voltage measurement has the Normal (Series) Mode Rejection Rate (NMRR) capability for 50/60 Hz noise, a hazardous voltage indication (⚡) will be shown even if the display is showing 0 V or < 30 V. The measurement range will automatically be set to a higher range, and the analog bar graph will be varying faster or greater than the displayed value.

NOTE

- Press and hold  for more than 1 second to scroll through the available dual display combinations. (Refer to “**Appendix B: Dual Display Combinations Using the Dual Key**” on page 143 for more information)
- Press  to enable the frequency test mode for voltage measurements. See “**Measuring Frequency**” on page 87 to learn more.

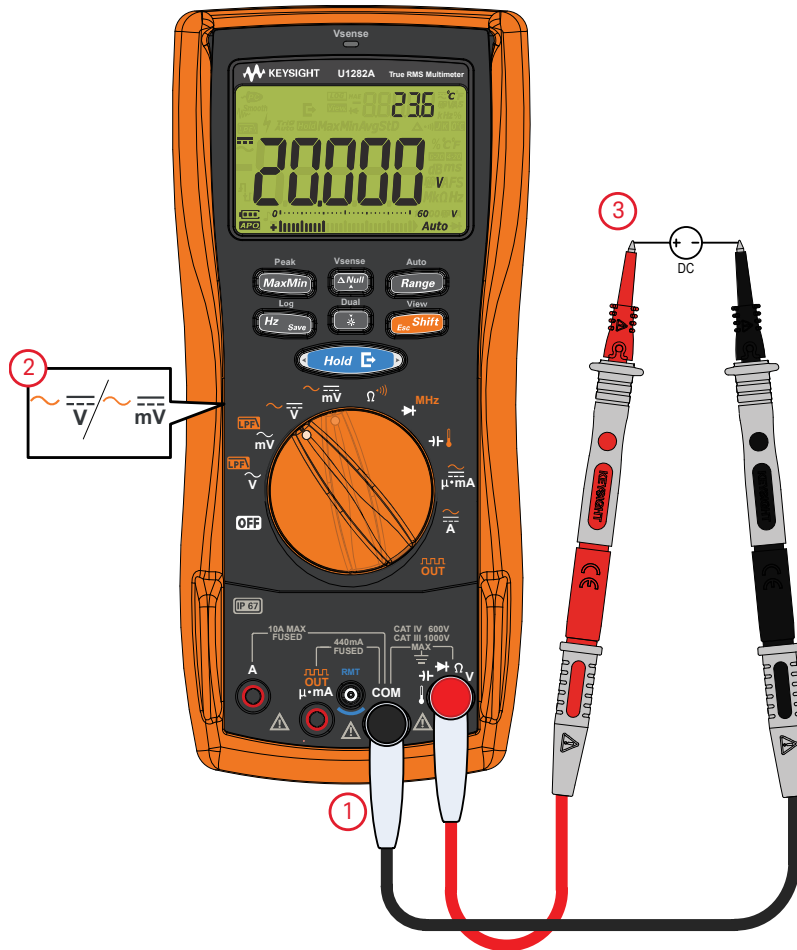







Figure 2-7 Measuring DC voltage

Measuring AC and DC Signals

Your multimeter is capable of displaying both AC and DC signal components, voltage or current, as two separate readings or one AC+DC (rms) value combined.

Table 2-4 Rotary switch positions allowing AC+DC signal measurements

Legend	Default function	Function when  is pressed
	DC V	Scrolls between - AC V - AC+DC V, or - DC V
	DC mV	Scrolls between - AC mV - AC+DC mV, or - DC mV
	DC A	Scrolls between - AC A - AC+DC A, or - DC A
	DC mA (or μ A)	Scrolls between - AC mA (or μ A) - AC+DC mA (or μ A), or - DC mA (or μ A)



Set up your multimeter according to your desired measurement (voltage or current measurement). Press the  key twice to change the measurement function to the AC+DC mode (). Probe the test points and read the display.



Figure 2-8 AC+DC voltage display

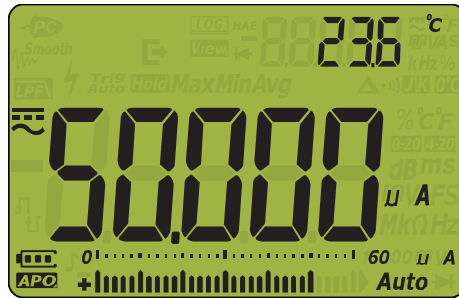



Figure 2-9 AC+DC current display

NOTE

- Press and hold  for more than 1 second to scroll through the available dual display combinations. (Refer to “**Appendix B: Dual Display Combinations Using the Dual Key**” on page **143** for more information)
- Press  to enable the frequency test mode for voltage measurements. See “**Measuring Frequency**” on page **87** to learn more.

Using the LPF (Low Pass Filter) Function for AC+DC measurements

Your multimeter is equipped with an AC LPF to help reduce electronic noise when measuring a mixed signal.

- 1 Enable the LPF (refer to “**Enabling the AC path filter (for U1282A only)**” on page 138).
- 2 Rotate the multimeter’s rotary switch to $\sim \overline{V}$.
- 3 Your multimeter continues measuring in the AC+DC mode, but now the signal diverts through a filter that blocks unwanted voltages above 1 kHz.

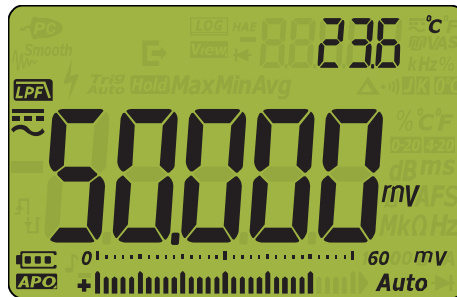

Figure 2-10 AC+DC voltage (with LPF) display

Making dB Measurements

Your multimeter is capable of displaying voltage as a dB value, either relative to 1 milliwatt (dBm) or a reference voltage of 1 volt (dBV).







To set the multimeter to display values in either dBm or dBV, first set up your multimeter to measure voltage as shown in **Figure 2-2** or **Figure 2-7**. Probe the test points, and read the display. Then, press and hold  for more than 1 second to scroll through the options until the voltage measurements are displayed either as a dBm value (see **Figure 2-11**) or a dBV value (see **Figure 2-12**)

Table 2-5 Rotary switch positions allowing dBm or dBV measurements

Legend	Default function	Function when  is pressed
	AC V	AC V with LPF
	AC mV	AC mV with LPF
	DC V	Scrolls between - AC V - AC+DC V, or - DC V
	DC mV	Scrolls between - AC mV - AC+DC mV, or - DC mV

NOTE

- A dBm measurement must use a reference impedance (resistance) to calculate a dB value based on 1 milliwatt. The reference impedance is set to 50 Ω by default. To select another reference value, see the “**Setting a custom dBm reference impedance**” on page 124.
- A dBV measurement uses a 1 volt reference voltage to compare the present measurement against a stored relative value. The difference between the two AC signals is displayed as a dBV value. The reference impedance setting is not part of a dBV measurement.

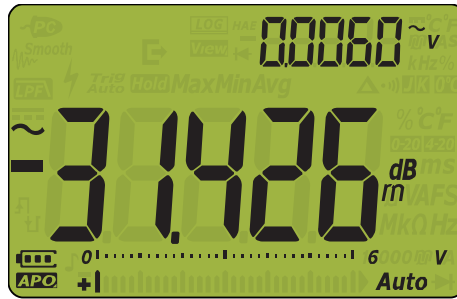



Figure 2-11 dBm display



Figure 2-12 dBV display

Press and hold  for more than 1 second to scroll through the options until you exit the dBm or dBV function. Selecting the frequency test mode  also cancels the dBm or dBV function.

Measuring Resistance

CAUTION

To avoid possible damage to your multimeter or to the equipment under test, disconnect the circuit power and discharge all high-voltage capacitors before measuring resistance.

Set up your multimeter to measure resistance as shown in **Figure 2-14**. Probe the test points and read the display.

Table 2-6 Rotary switch position allowing resistance measurements

Legend	Default function	Function when  is pressed
Ω	Resistance measurement (Ω)	Continuity test (\bullet)



Figure 2-13 Resistance display

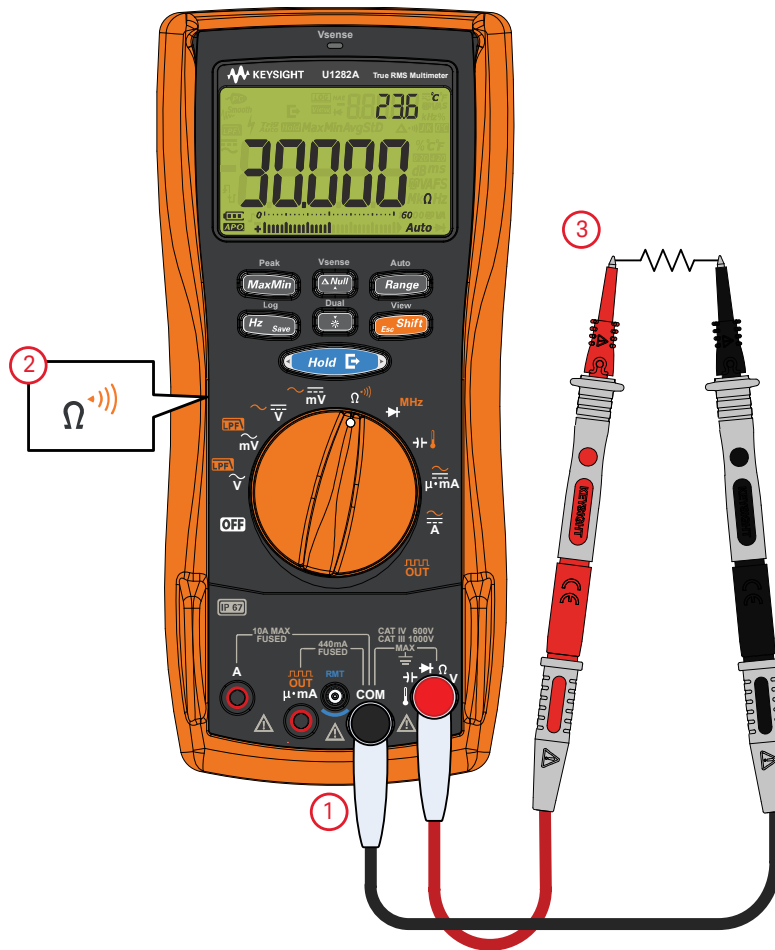



Figure 2-14 Measuring resistance

NOTE

Keep the following in mind when measuring resistance.

- The test leads can add 0.1 Ω to 0.2 Ω of error to resistance measurements. To test the leads, touch the probe tips together and read the resistance of the leads. To remove lead resistance from the measurement, hold the test lead tips together and press . Now the resistance at the probe tips will be subtracted from all future display readings.

Measuring conductance

Small conductance values correspond to extremely high resistance values. The nS range allows you to easily calculate and determine the resistance of components up to 100 G Ω (0.01 nS resolution).

To measure conductance, set up your multimeter to measure resistance as shown in

Figure 2-14. Press  until the conductance measurement is selected (nS unit shown). Probe the test points, and read the display.

High-resistance readings are susceptible to electrical noise. Use averaging to smooth out most of the noisy readings.



Testing for Continuity

CAUTION

To avoid possible damage to your multimeter or to the equipment under test, disconnect the circuit power and discharge all high-voltage capacitors before testing for continuity.

Set up your multimeter to test for continuity as shown in **Figure 2-15**. Probe the test points and read the display.

Table 2-7 Rotary switch position allowing continuity tests

Legend	Default function	Function when  is pressed
	Resistance measurement (Ω)	Continuity test ()

NOTE

The continuity test features a beeper that sounds and a red LED that turns on as long as a circuit is incomplete or broken. The audible and visual alert allow you to perform quick continuity tests without having to watch the display.

In continuity, a short means a measured value is less than the threshold resistance values listed in **Table 2-8**.

Table 2-8 Threshold resistance values

Range	Resolution	Accuracy	Continuity threshold	Overload protection
60.000 Ω	0.001 Ω	0.15% +20	5 \pm 3 Ω	1000 Vrms < 3 A short circuit current
600.00 Ω	0.01 Ω	0.05% +10	25 \pm 11 Ω	
6.0000 k Ω	0.0001 k Ω	0.05% +2	0.123 \pm 0.052 k Ω	
60.000 k Ω	0.001 k Ω	0.05% +2	1.12 \pm 0.5 k Ω	
600.00 k Ω	0.01 k Ω	0.05% +2	12.1 \pm 5.2 k Ω	
6.0000 M Ω	0.0001 M Ω	0.15% +2	0.109 \pm 0.05 M Ω	
60.000 M Ω	0.001 M Ω	1.5% +3	0.109 \pm 0.05 M Ω	
600.00 M Ω	0.01 M Ω	3.0% +3 (< 100 M Ω) 8.0% +3 (< 600 M Ω)	0.109 \pm 0.05 M Ω	
600.00 nS	0.01 nS	1% +20	None	

You can set the beeper to sound and the Vsense LED to turn on as a continuity indication whether the circuit-under-test is less than (short) or more than or equal to (open) the threshold resistance (refer to “**Changing the continuity type**” on page 129).

- Normal open: Circuit is normally open, the beeper will sound and the LED will turn on when a short is detected.
- Normal closed: Circuit is normally closed, the beeper will sound and the LED will turn on when an open is detected.

The audible continuity will be locked in the 600 Ω range for resistance measurement.

NOTE

- The continuity function detects intermittent shorts and opens lasting as briefly as 1 ms. A brief short or open causes the multimeter to emit a short beep and flash.
 - You can enable or disable the audible and visual alert via the multimeter’s Setup. See “**Changing the continuity alert type**” on page 130 for more information on the audible alert option.
-

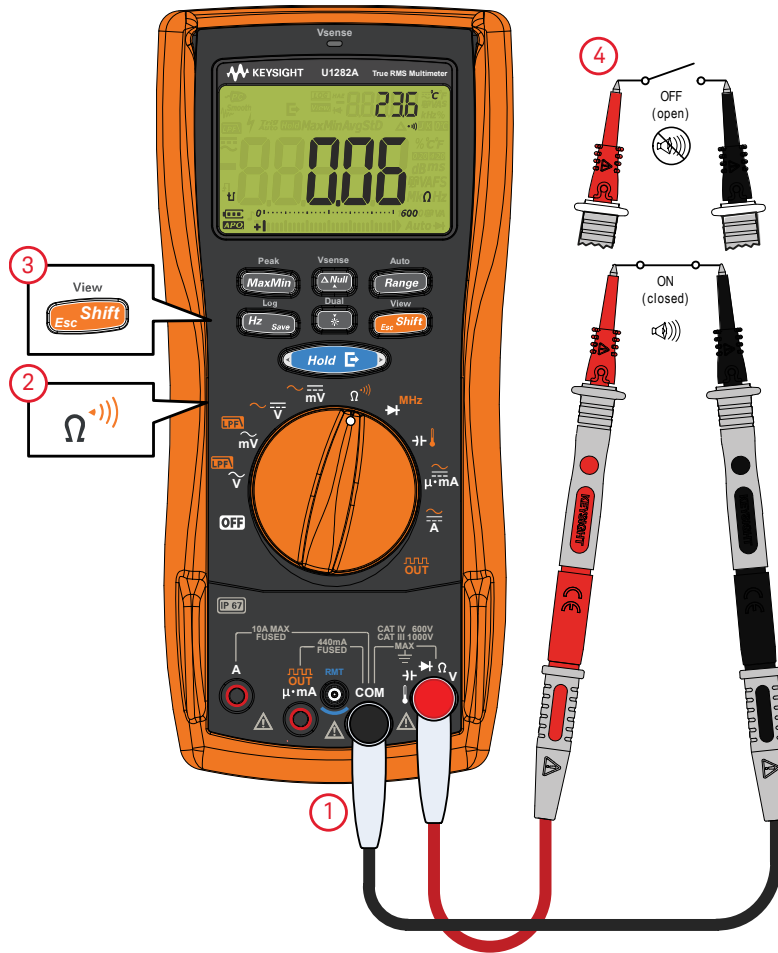

Figure 2-15 Testing for continuity



Testing Diodes

CAUTION

To avoid possible damage to your multimeter or to the equipment under test, disconnect the circuit power and discharge all high-voltage capacitors before testing diodes.

Set up your multimeter to test diodes as shown in **Figure 2-18**. Probe the test points and read the display.

Table 2-9 Rotary switch position allowing diode tests

Legend	Default function	Function when  is pressed
 MHz	Diode test	Frequency counter

NOTE

- Use the diode test to check diodes, transistors, silicon controlled rectifiers (SCRs), and other semiconductor devices. A good diode allows current to flow in one direction only.
- This test sends a current through a semiconductor junction and then measures the junction's voltage drop. A typical junction drop is 0.3 V to 0.8 V.
- Connect the red test lead to the positive terminal (anode) of the diode and the black test lead to the negative terminal (cathode).



Figure 2-16 Diode display

NOTE

- Your multimeter can display diode forward bias of up to approximately 3.1 V. The forward bias of a typical diode is within the range of 0.3 V to 0.8 V; however, the reading can vary depending on the resistance of other pathways between the probe tips.
- If the beeper is enabled during a diode test, the multimeter will beep briefly for a normal junction and sound continuously for a shorted junction below 0.050 V. See “**Changing the beep frequency**” on page 127 to disable the beeper.

Reverse the probes (as shown in **Figure 2-19**) and measure the voltage across the diode again. Assess the diode according to the following guidelines:

- A diode is considered good if the multimeter displays **OL** in reverse bias mode.
- A diode is considered shorted if the multimeter displays approximately 0 V in both forward and reverse bias modes, and the multimeter beeps continuously.
- A diode is considered open if the multimeter displays **OL** in both forward and reverse bias modes.



Figure 2-17 Open diode display

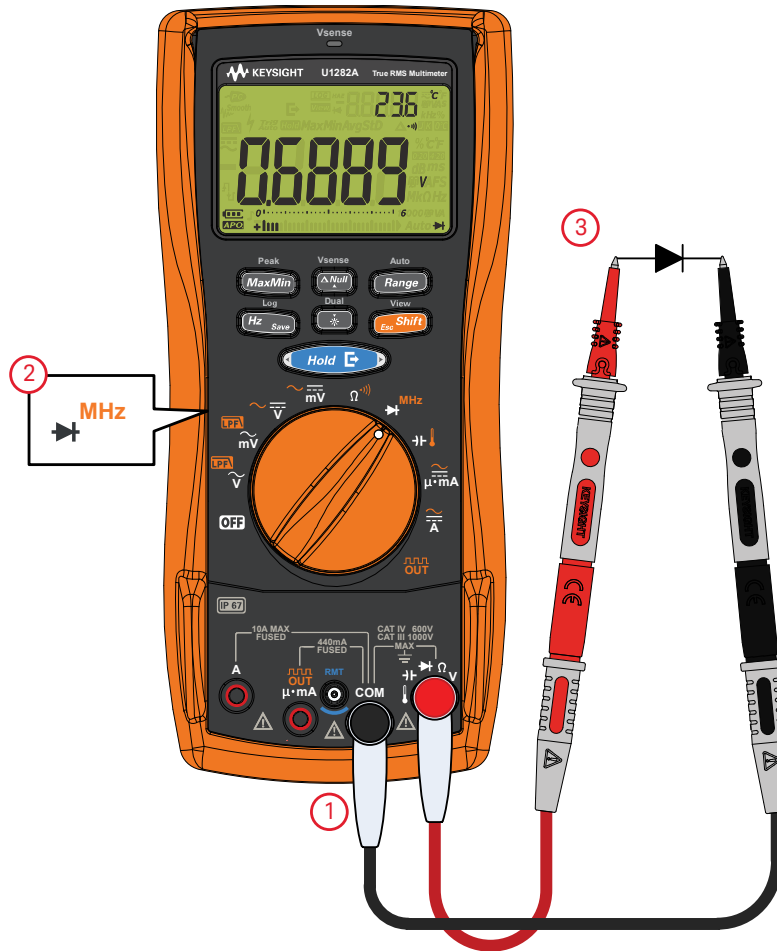

Figure 2-18 Testing a forward-bias diode

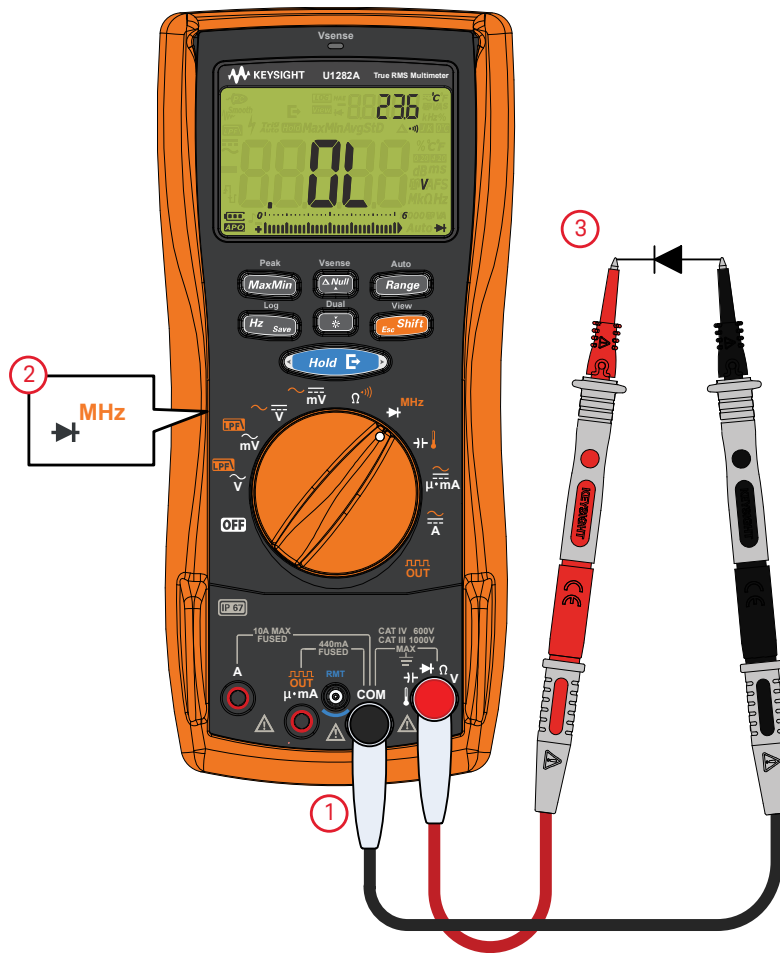





Figure 2-19 Testing a reverse-bias diode

Frequency Counter (for U1282A only)

WARNING

- Use the frequency counter for low voltage applications. Never use the frequency counter on AC power line systems.
 - For input more than $\pm 1.8 V_p$, you are required to use the frequency measurement mode available under the current or voltage measurement instead of the frequency counter.
-

The frequency counter can be set to divide a signal for megahertz (MHz) measurement. You can use this to measure the stability of the crystal oscillator clock over time.

- 1 Position the rotary switch to  **MHz**.
- 2 Press  to select the frequency counter mode.
- 3 Probe the test points and read the display.
- 4 If the reading is unstable, press  to toggle between a **Hz** or a **MHz** reading.

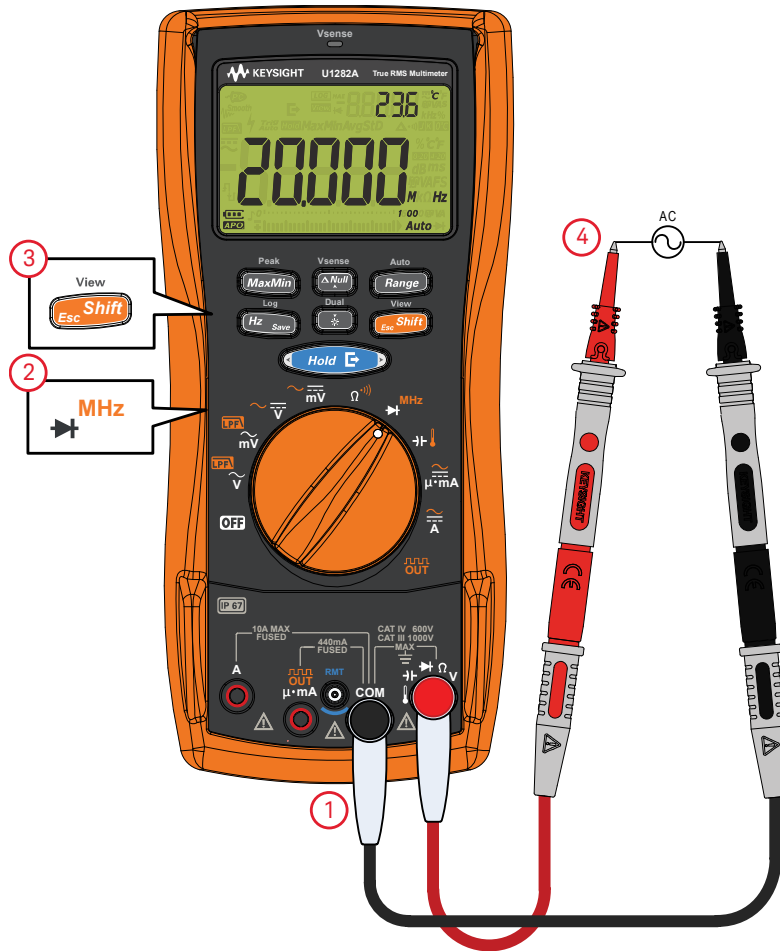

Figure 2-20 Frequency counter mode



Measuring Capacitance

CAUTION

To avoid possible damage to the multimeter or to the equipment under test, disconnect circuit power and discharge all high-voltage capacitors before measuring capacitance. Use the DC voltage function to confirm that the capacitor is fully discharged.

Set up your multimeter to measure capacitance as shown in **Figure 2-22**. Probe the test points and read the display.

Table 2-10 Rotary switch position allowing capacitance measurements

Legend	Default function	Function when  is pressed
	Capacitance measurement	Temperature measurement

NOTE



- The multimeter measures capacitance by charging the capacitor with a known current for a known period of time, measuring the resulting voltage, and then calculating the capacitance.
-  is shown on the bottom left of the display when the capacitor is charging, and  is shown when the capacitor is discharging.
- To improve measurement accuracy of small value capacitors, press  with the test leads open to subtract the residual capacitance of the multimeter and leads.
- For measuring capacitance values greater than 1000 μF , discharge the capacitor first, then select a suitable range for measurement. This will speed up the measurement time and also ensure that the correct capacitance value is obtained.



Figure 2-21 Capacitance display

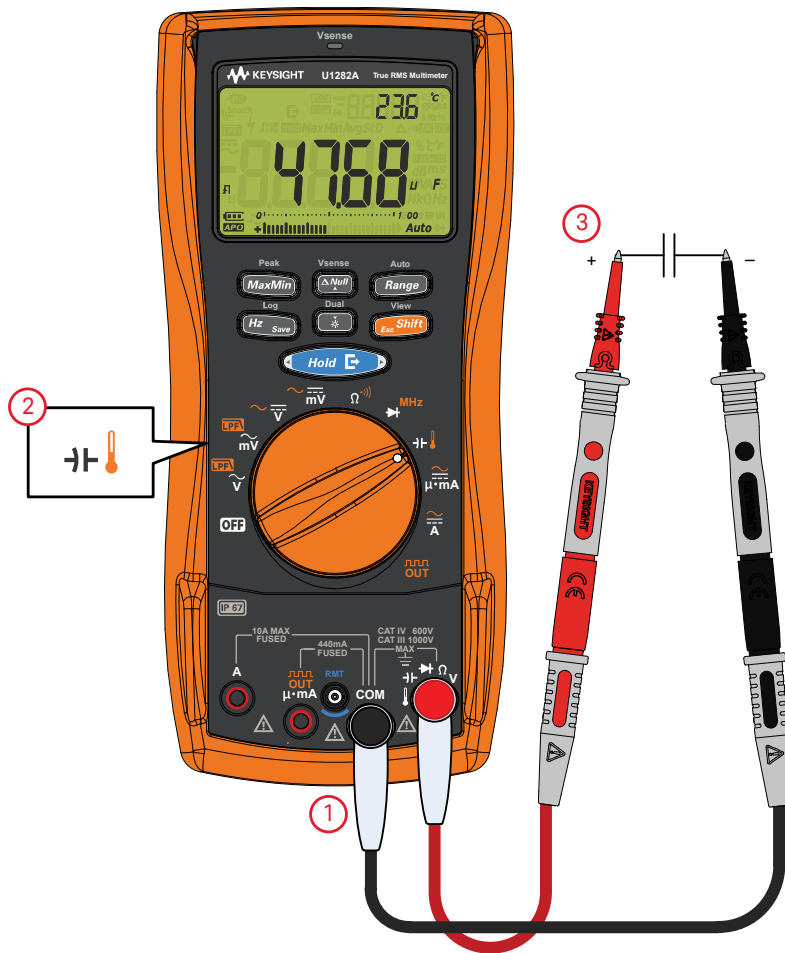

Figure 2-22 Measuring capacitance

Measuring Temperature

WARNING



Do not connect the thermocouple to electrically live circuits. Doing so will potentially cause fire or electric shock.



CAUTION

- Do not bend the thermocouple leads at sharp angles. Repeated bending over a period of time can break the leads.
- Always set the temperature unit display per the official requirements and in compliance with the National laws of your region.

The multimeter uses a type-K (default setting) temperature probe for measuring temperature. To measure temperature, set up your multimeter as shown in **Figure 2-24**.

Table 2-11 Rotary switch position allowing temperature measurements

Legend	Default function	Function when  is pressed
	Capacitance measurement	Temperature measurement

Probe the test points and read the display. The primary display normally shows temperature or the message  (open thermocouple). The open thermocouple message may be due to a broken (open) probe or because no probe is installed into the input jacks of the multimeter. Press and hold  for more than 1 second to change the temperature units between °C or °F

NOTE

- Shorting the  terminal to the **COM** terminal will display the temperature at the multimeter's terminals.
- To change the default thermocouple type from type-K to type-J, see “**Changing the thermocouple type**” on page 125 for more information.



Figure 2-23 Temperature display

NOTE

The bead-type thermocouple probe is suitable for measuring temperatures from $-40\text{ }^{\circ}\text{C}$ to $204\text{ }^{\circ}\text{C}$ ($399\text{ }^{\circ}\text{F}$) in PTFE-compatible environments. Do not immerse this thermocouple probe in any liquid. For best results, use a thermocouple probe designed for each specific application – an immersion probe for liquid or gel, and an air probe for air measurement.

Observe the following measurement techniques:

- Clean the surface to be measured, and ensure that the probe is securely touching the surface. Remember to disable the applied power.
- When measuring above ambient temperatures, move the thermocouple along the surface until you get the highest temperature reading.
- When measuring below ambient temperatures, move the thermocouple along the surface until you get the lowest temperature reading.
- Place the multimeter in the operating environment for at least 1 hour as the multimeter is using a non-compensation transfer adapter with miniature thermal probe.
- Avoid placing the multimeter in areas where there are high temperature variations.
- Cool down the multimeter after measuring high current signals.

For quick measurement, use the 0°C compensation to view the temperature variation of the thermocouple sensor. The 0°C compensation assists you in measuring relative temperature immediately without compensating for the ambient temperature.

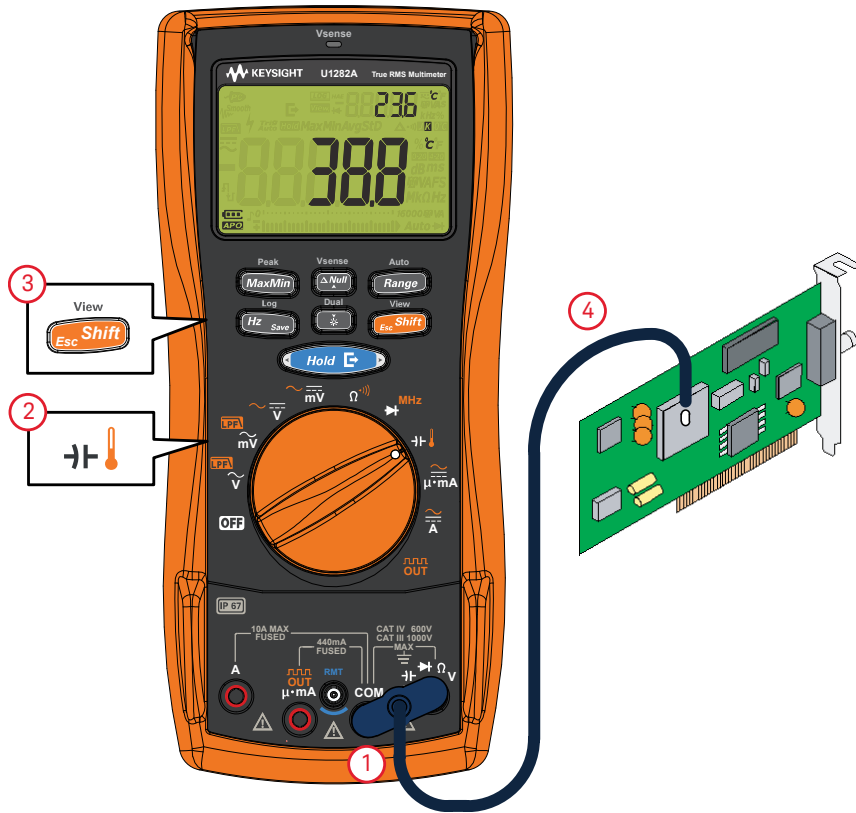

Figure 2-24 Measuring temperature

Temperature measurement without ambient compensation

If you are working in a constantly varying environment, where ambient temperatures are not constant, do the following:

- 1 Press ^{Auto} **Range** to select **0°C** compensation. This allows for a quick measurement of the relative temperature.
- 2 Avoid contact between the thermocouple probe and the surface to be measured.
- 3 After a constant reading is obtained, press ^{Vsense} **Null** to set the reading as the relative reference temperature.
- 4 Touch the surface to be measured with the thermocouple probe and read the display.



Figure 2-25 Temperature measurement without ambient compensation

Measuring AC or DC Current

WARNING



- Before attempting any current measurement, switch off the power source of the circuit and measure the AC or DC voltage to ensure that the power source has been switched off.
- Never attempt an in-circuit current measurement where the open-circuit potential to earth is greater than 1000 V. Doing so will cause damage to the multimeter and possible electric shock or personal injury.

CAUTION

- To avoid possible damage to the multimeter or to the equipment under test:
 - Check the multimeter’s fuses before measuring current.
 - Use the proper terminals, function, and range for your measurement.
 - Never place the probes across (in parallel with) any circuit or component when the leads are plugged into the current terminals.
- Current can be measured at 440 mA continuously, and > 440 mA to 600 mA for 20 hours maximum. After measuring > 440 mA current, cool down the multimeter for twice the measuring time taken and use the Null (Δ) function (refer to “**Making Relative Measurements (Null)**” on page 98) to zero the thermal effect before proceeding for low current measurement.
- Current can be measured at 10 A continuously, and 10 A ~ 20 A for 30 seconds maximum. After measuring > 10 A current, cool down the multimeter for twice the measuring time taken before proceeding for low current measurement.

Set up your multimeter to measure AC or DC current as shown in **Figure 2-27**. Open the circuit path to be tested. Probe the test points, and read the display.

Table 2-12 Rotary switch positions allowing current measurements

Legend	Default function	Function when  is pressed
	DC A	Scrolls between <ul style="list-style-type: none"> – AC A – AC+DC A, or – DC A
	DC mA (or μ A)	Scrolls between <ul style="list-style-type: none"> – AC mA (or μA) – AC+DC mA (or μA), or – DC mA (or μA)









CAUTION

- To avoid blowing the multimeter's 440 mA fuse, use the μmA terminal only if you are sure the current is less than 440 mA. Refer to the **Input warning** section for information on the alerts the multimeter uses when leads are not used correctly for current measurements.
- Placing the probes across (in parallel with) a powered circuit when a lead is plugged into a current terminal can damage the circuit you are testing and blow the multimeter's fuse. This happens because the resistance through the multimeter's current terminals is very low, resulting in a short circuit.



Figure 2-26 DC current display

NOTE

- To measure current, you must open the circuit-under-test, then place the multimeter in series with the circuit.
 - Turn off power to the circuit. Discharge all high-voltage capacitors. Insert the black test lead into the **COM** terminal. Insert the red test lead in an input appropriate for the measurement range.
 - If you are using the **A** terminal, set the rotary switch to .
 - If you are using the **μ•mA** terminal, set the rotary switch to  for current below 440 mA, or  for current above 440 mA but below 10 A.
 - Press  to scroll between DC () , AC () , or AC+DC () current measurements.
 - Reversing the leads will produce a negative reading, but will not damage the multimeter.
 - Press and hold  for more than 1 second to scroll through the available dual display combinations (refer to “**Appendix B: Dual Display Combinations Using the Dual Key**” on page **143** for more information).
 - Press  to enable the frequency test mode for current measurements. See “**Measuring Frequency**” on page **87** to learn more.
-

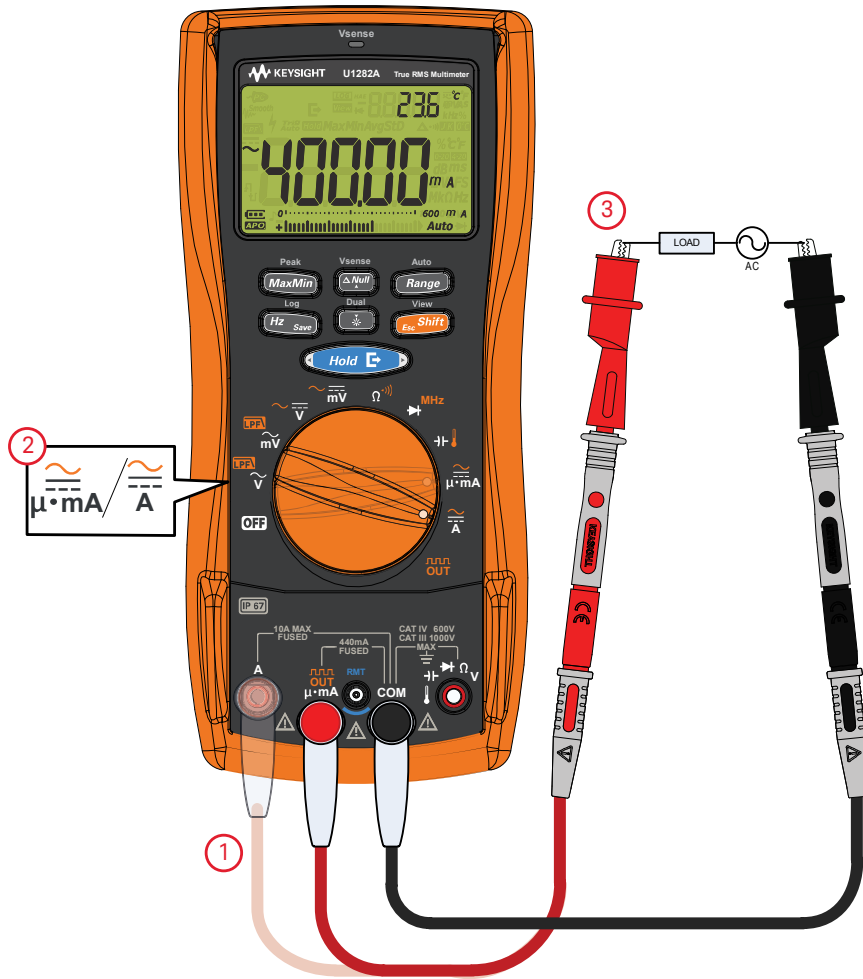

Figure 2-27 Measuring AC or DC current

% Scale of 4-20 mA or 0-20 mA



To display the current measurement in % scale, position your multimeter's rotary switch position to μmA and set up your multimeter to measure DC current by following the steps listed in the **Measuring AC or DC Current** section. Press and hold  for more than 1 second to scroll through the options until **% 0-20** (or **% 4-20**) is shown on the right side of the display.

Table 2-13 Rotary switch positions allowing current measurements in % scale

Legend	Default function	Function when  is pressed
μmA	DC mA (or μA)	Scrolls between - AC mA (or μA) - AC+DC mA (or μA), or - DC mA (or μA)

NOTE

- The 4-20 mA current loop output from a transmitter is a type of electrical signal that is used in a series circuit to provide a robust measurement signal that is proportional to the applied pressure, temperature, or flow in process control. The signal is a current loop where 4 mA represents the zero percent signal and 20 mA represents the 100 percent signal.
- The % scale for 4-20 mA or 0-20 mA in this multimeter is calculated using its corresponding DC mA measurement. The multimeter will automatically optimize the best resolution for the selected measurement.



Figure 2-28 4-20 mA % scale display



Figure 2-29 0-20 mA % scale display

The analog bar graph displays the current measurement value. (In the example above, 8 mA is represented as 40% in the 0-20 mA % scale and 25% in the 4-20 mA % scale.)

Table 2-14 % Scale measurement range

% Scale of 4-20 mA or 0-20 mA	DC mA measurement range
999.99%	~ 600 mA ^[a]
9999.9%	

[a] Applies to both autoranging and manual range selection

Use the % scale with a pressure transmitter, a valve positioner, or other output actuators to measure pressure, temperature, flow, pH, or other process variables.

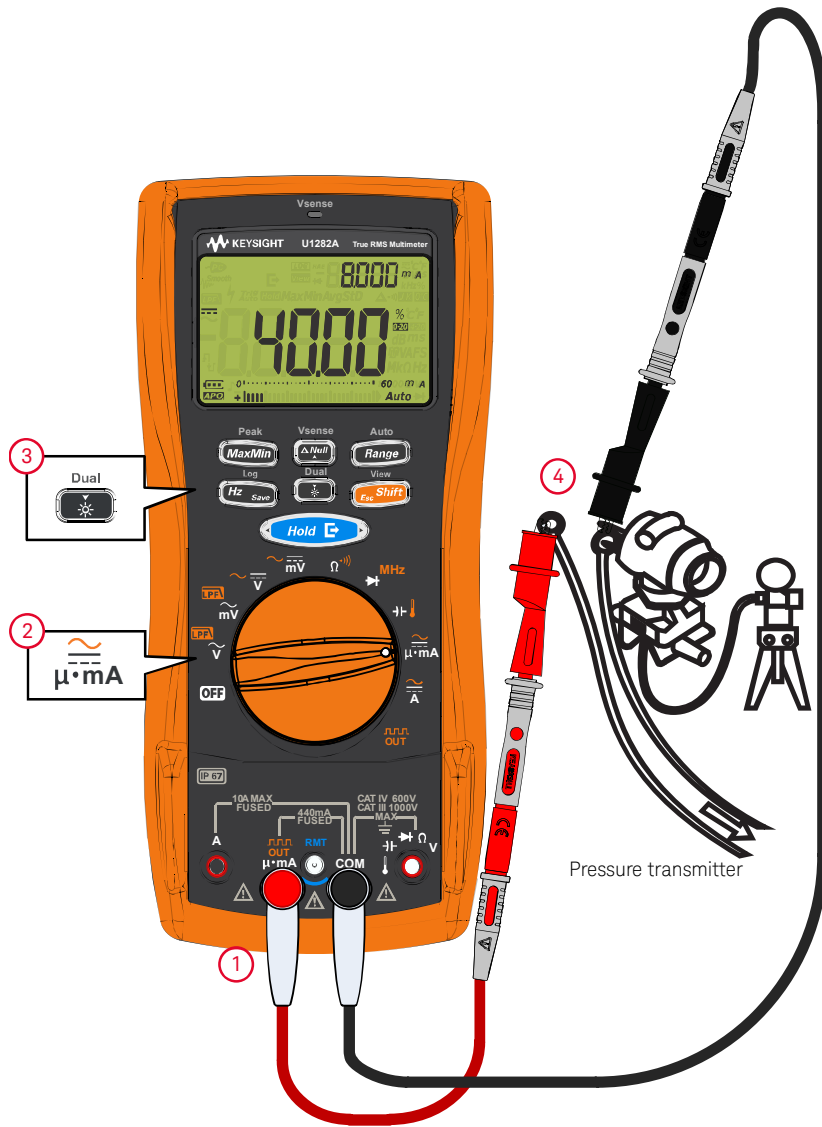

Figure 2-30 Measuring DC current using the 0-20 mA % scale







Measuring Frequency

WARNING

Never measure the frequency where the voltage or current level exceeds the specified range. Manually set the voltage or current range if you want to measure frequencies below 20 Hz.

Your multimeter allows simultaneous monitoring of real-time voltage or current with frequency, duty cycle, or pulse width measurements. **Table 2-15** highlights the primary functions allowing frequency measurements in your multimeter.

Table 2-15 Rotary switch positions allowing frequency measurements

Legend	Default function	Function when  is pressed
	AC V	AC V with LPF
	AC mV	AC mV with LPF
	DC V	Scrolls between - AC V - AC+DC V, or - DC V
	DC mV	Scrolls between - AC mV - AC+DC mV, or - DC mV
	DC A	Scrolls between - AC A - AC+DC A, or - DC A
	DC mA (or μ A)	Scrolls between - AC mA (or μ A) - AC+DC mA (or μ A), or - DC mA (or μ A)

To measure frequency, rotate the switch to one of the primary functions allowing frequency measurements highlighted in **Table 2-15**. Press  (Log Hz Save), then probe the test points and read the display.

Pressing  (Auto Range) controls the input range of the voltage or ampere function, not the frequency range.



Figure 2-31 Frequency display

The frequency of the input signal is shown in the primary display. The voltage or ampere value of the signal is shown in the secondary display. The bar graph does not indicate frequency but indicates the voltage or ampere value of the input signal.

NOTE

- Measuring the frequency of a signal helps detect the presence of harmonic currents in neutral conductors and determines whether these neutral currents are the result of unbalanced phases or non-linear loads.
- Frequency is the number of cycles a signal completes each second. Frequency is defined as $1/\text{Period}$. Period is defined as the time between the middle threshold crossings of two consecutive, like-polarity edges, as shown in **Figure 2-32**.
- The multimeter measures the frequency of a voltage or current signal by counting the number of times the signal crosses a threshold level within a specified period of time.
- To obtain the best measuring results for frequency measurements, please use the AC measuring path.

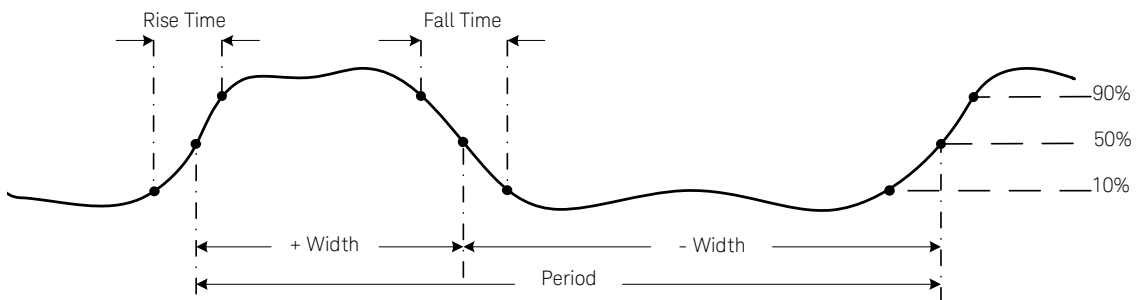





Figure 2-32 Frequency, pulse width, and duty cycle measurements

NOTE

Observe the following measurement techniques:

- If a reading shows 0 Hz or is unstable, the input signal may be below or near the trigger level. You can usually correct these problems by manually selecting a lower input range, which increases the sensitivity of the multimeter.
 - If a reading seems to be a multiple of what you expect, the input signal may be distorted. Distortion can cause multiple triggerings of the frequency counter. Selecting a higher voltage range might solve this problem by decreasing the sensitivity of the multimeter. In general, the lowest frequency displayed is the correct one.
-

Press  to scroll through the frequency, pulse width, and duty cycle measurements.

Press  to scroll back to the frequency measurement mode, and hold  for more than 1 second to exit the frequency measurement function.

Measuring pulse width

NOTE

The pulse width function measures the amount of time a signal is high or low, as shown in **Figure 2-32**. It is the time from the middle threshold of the rising edge to the middle threshold of the next falling edge. The measured waveform must be periodic; its pattern must repeat at equal time intervals.





- 1 To measure pulse width, position the rotary switch to one of the functions allowing frequency measurements shown in **Table 2-15**.
- 2 Press  until the measurements are shown in the millisecond (ms) unit. Probe the test points and read the display.





Figure 2-33 Pulse width display

The pulse width of the input signal is shown in the primary display. The voltage or ampere value of the signal is shown in the secondary display. The bar graph does not indicate pulse width but indicates the voltage or ampere value of the input signal.

The pulse width polarity is displayed to the left of the pulse width value.  indicates a positive pulse width and  indicates a negative pulse width. To change the polarity being measured, press and hold  for more than 1 second.

Press  to scroll through the frequency, pulse width, and duty cycle measurements.

Press  to scroll back to the frequency measurement mode, and hold  for more than 1 second to exit the frequency measurement function.

Measuring duty cycle

NOTE

The duty cycle (or duty factor) of a repetitive pulse train is the ratio of the positive or negative pulse width to the period expressed as a percentage, as shown in **Figure 2-32**.

The duty cycle function is optimized for measuring the on or off time of logic and switching signals. Systems such as electronic fuel injection systems and switching power supplies are controlled by pulses of varying width, which can be checked by measuring duty cycle.



- 1 To measure duty cycle, position the rotary switch on one of the functions allowing frequency measurements shown in **Table 2-15**.
- 2 Press  until the measurements are displayed as a percentage (%). Probe the test points and read the display.





Figure 2-34 Duty cycle display

The duty cycle percentage of the input signal is shown in the primary display. The voltage or ampere value of the signal is shown in the secondary display. The bar graph does not indicate duty cycle but indicates the voltage or ampere value of the input signal.

The pulse polarity is displayed to the left of the duty cycle value.  indicates a positive pulse and  indicates a negative pulse. To change the polarity being measured, press and hold

the  for more than 1 second.

Press  to scroll through the frequency, pulse width, and duty cycle measurements.

Press  to scroll back to the frequency measurement mode, and hold  for more than 1 second to exit the frequency measurement function.

Square Wave Output

The multimeter's square wave output can be used to generate a PWM (pulse width modulation) output or provide a synchronous clock source (baud rate generator). You can also use this function to check and calibrate flow-meter displays, counters, tachometers, oscilloscopes, frequency converters, frequency transmitters, and other frequency input devices.

Selecting square wave output frequency

- 1 Position the rotary switch to **OUT**. The default duty cycle is 50.000% and the default frequency is 600 Hz, as shown on the primary and secondary displays respectively.
- 2 Press **View** **Esc Shift** to switch between duty cycle and pulse width for the primary display.
- 3 Press **◀** or **▶** on **Hold** **Log** or **Hz Save** to scroll through the available frequencies (there are 29 frequencies to choose from).
- 4 Press **Vsense** **Null** or **Dual** to change the duty cycle or pulse width values.



Figure 2-35 Square wave output display



Figure 2-36 Square wave output

THIS PAGE HAS BEEN INTENTIONALLY LEFT BLANK.

Keysight U1281A/U1282A
Handheld Digital Multimeter
User's Guide

3 Multimeter Features

Non-Contact AC Voltage Detection (Vsense)	96
Making Relative Measurements (Null)	98
Capturing Maximum and Minimum Values (MaxMin)	100
Capturing Peak Values (Peak)	102
Freezing the Display (TrigHold and AutoHold)	104
Recording Measurement Data (Data Logging)	105
Performing manual logs (HAnd)	106
Performing interval logs (AUto)	106
Performing event logs (triG)	108
Performing export logs	109
Reviewing Previously Recorded Data (View)	111

The following sections describe the additional features available in your multimeter.

Non-Contact AC Voltage Detection (Vsense)

Vsense is a non-contact voltage detector that detects the presence of AC voltages nearby.

WARNING

- You are advised to test on a known live circuit within the rated AC voltage range of this product before and after each use to ensure that Vsense works.
- Voltage could still be present even if there is no Vsense alert indication. Do not rely on Vsense with shielded wires. Never touch live voltage or conductors without the necessary insulation protection or switching off the voltage source.
- Vsense may be affected by differences in socket design, insulation thickness, and insulation type.

CAUTION



You are advised to measure voltage by using test leads through the voltage measurement function after using Vsense, even if there is no alert indication.

- 1 Press and hold  to enable Vsense (on any position of the rotary switch except **OFF** and **OUT**).

NOTE

If the multimeter senses the presence of AC voltage, the multimeter will beep and the red Vsense LED at the top of the multimeter will turn on. The ⚡ symbol will also be displayed on the LCD. The audible and visual alert allows you to easily sense the presence of AC voltage in close proximity.

No resolution and accuracy of voltage measurement will be displayed in this mode.

- 2 Press  to toggle the Vsense's sensitivity between high sensitivity (**Hi.SE**) or low sensitivity (**Lo.SE**).
- 3 Press and hold  again to disable Vsense.

NOTE

When Vsense is disabled, the multimeter will return to the primary function of the current rotary knob position regardless of what function it was in before Vsense was enabled.

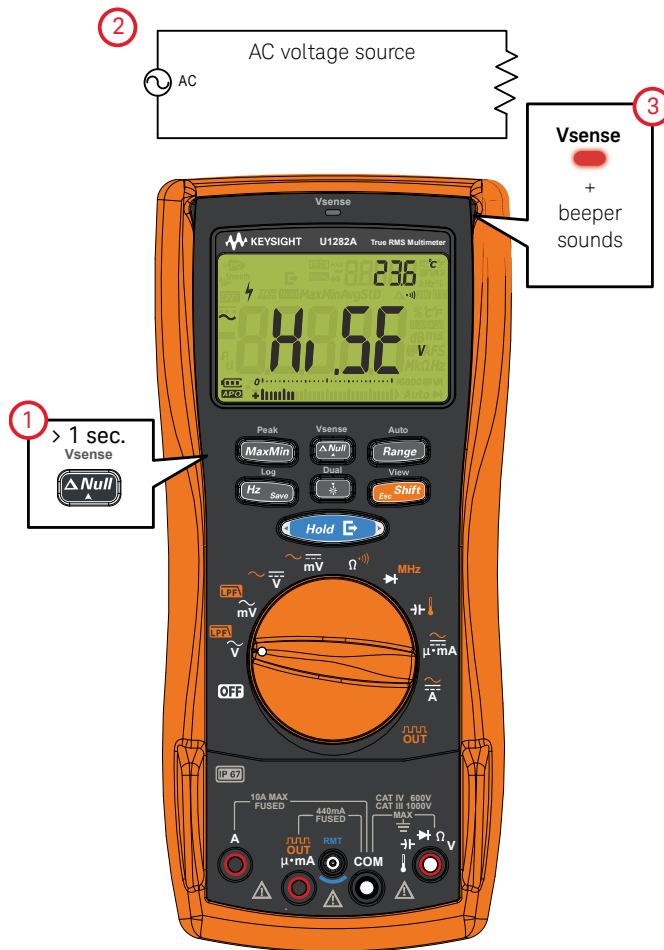

Figure 3-1 Non-contact AC voltage detector (Vsense) mode

Making Relative Measurements (Null)

When making null measurements – also known as relative measurements – each reading is the difference between a null value (stored or measured) and the input signal.

One possible application is to increase the accuracy of a resistance measurement by nulling the test lead resistance. Nulling the leads is also particularly important prior to making capacitance measurements.



NOTE

Null can be set for both auto and manual range settings, but an overload reading cannot be stored as a null value.

- 1 To activate the relative mode, press the  key. The measurement value at the time that when Null (Δ) is enabled, is stored as the reference value.



Figure 3-2 Null display

- 2 Press  again to view the stored reference value. The display will return to normal after a brief moment.
- 3 To disable the Null function, press  while the stored reference value is shown. For any measurement function, you can directly measure and store the null value by pressing  with the test leads open (nulls the test lead capacitance), shorted (nulls the test lead resistance), or across a desired null value circuit.

NOTE

- In resistance measurement, the multimeter will read a non-zero value, even when the two test leads are in direct contact, because of the resistance of these leads. Use the null function to zero-adjust the display.
- For DC voltage measurements, the thermal effect will influence the accuracy of the measurements. Short the test leads and press  when the displayed value is stable to zero-adjust the display.

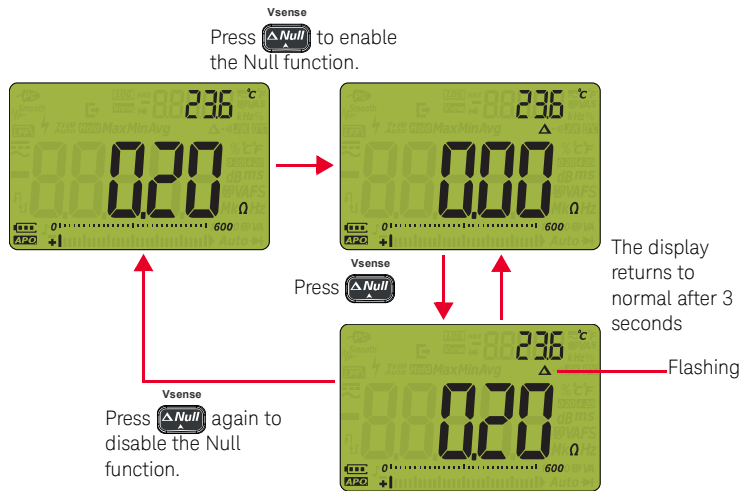



Figure 3-3 Null operation

Capturing Maximum and Minimum Values (MaxMin)

The MaxMin operation stores the maximum, minimum, and average input values during a series of measurements. When the input goes below the recorded minimum value or above the recorded maximum value, the multimeter beeps and records the new value. The elapsed time since the recording session was started is stored and shown on the display at the same time. The multimeter also calculates an average of all readings taken since the MaxMin mode was activated.

From the multimeter's display, you can view the following statistical data for any set of readings:

- Max: highest reading since the MaxMin function was enabled
- Min: lowest reading since the MaxMin function was enabled
- Avg: average or mean of all readings since the MaxMin function was enabled
- MaxMinAvg: present reading (actual input signal value)

- 1 Press  to enable the MaxMin operation.
- 2 Press  again to scroll through the Max, Min, Avg, or present (MaxMinAvg) input values.

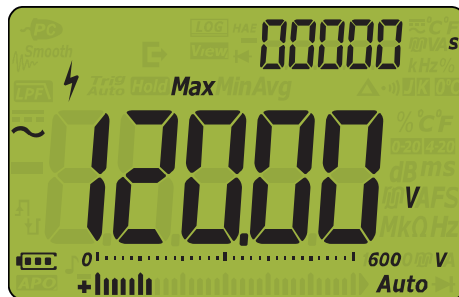





Figure 3-4 MaxMin display

- 3 The elapsed time is shown on the secondary display. Press  to restart the recording session.

NOTE

- Changing the range manually will also restart the recording session.
 - If an overload is recorded, the averaging function will be stopped.  is shown in place of the average value.
 - The APO (Auto Power-Off) function is disabled when MaxMin is enabled.
 - The maximum recording time is 99999 seconds (27 hours, 46 minutes, 39 seconds).
 is shown if the recording exceeds the maximum time.
-

- 4 Press  for more than 1 second to disable the MaxMin function.

This mode is useful for capturing intermittent readings, recording minimum and maximum readings unattended, or recording readings while equipment operation keeps you from observing the multimeter display.

The average value displayed is the true arithmetic mean of all readings taken since the start of recording. The average reading is useful for smoothing out unstable inputs, calculating power consumption, or estimating the percentage of time a circuit is active.

Capturing Peak Values (Peak)

This function allows the measurement of peak voltage for analysis of such components as power distribution transformers and power factor correction capacitors.

- 1 To activate the peak mode, press the ^{Peak} **MaxMin** key for more than 1 second.
- 2 Press ^{Peak} **MaxMin** again to display the maximum (HoldMax) or minimum (HoldMin) peak values along with their respective time stamps.

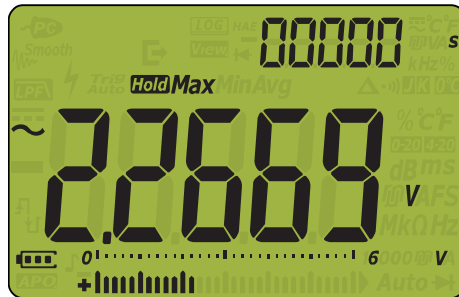

Figure 3-5 Peak display

- 3 If **OL** (overload) is shown, press the ^{Auto} **Range** key to change the measurement range. This action will also restart the measurement.
- 4 Press **Hold** to restart the measurement without changing the measurement range.
- 5 Press ^{Peak} **MaxMin** for more than 1 second to disable the Peak function.

When the peak value of the input signal goes below the recorded minimum value or above the recorded maximum value, the multimeter beeps and records the new value.

At the same time, the elapsed time since the peak recording session was started is stored as the recorded value's time stamp.

NOTE

The Auto Power-Off (APO) function is disabled when Peak is enabled.

To calculate the crest factor

Crest factor is a measure of signal distortion and is calculated as a signal's peak value over its rms value. This is an important measurement when looking at power quality issues. In the measurement example shown below (**Figure 3-6**), the crest factor is calculated as:

$$\text{Crest factor} = \frac{\text{Peak value}}{\text{True rms value}} = \frac{2.2669\text{V}}{1.6032\text{V}} = 1.414$$

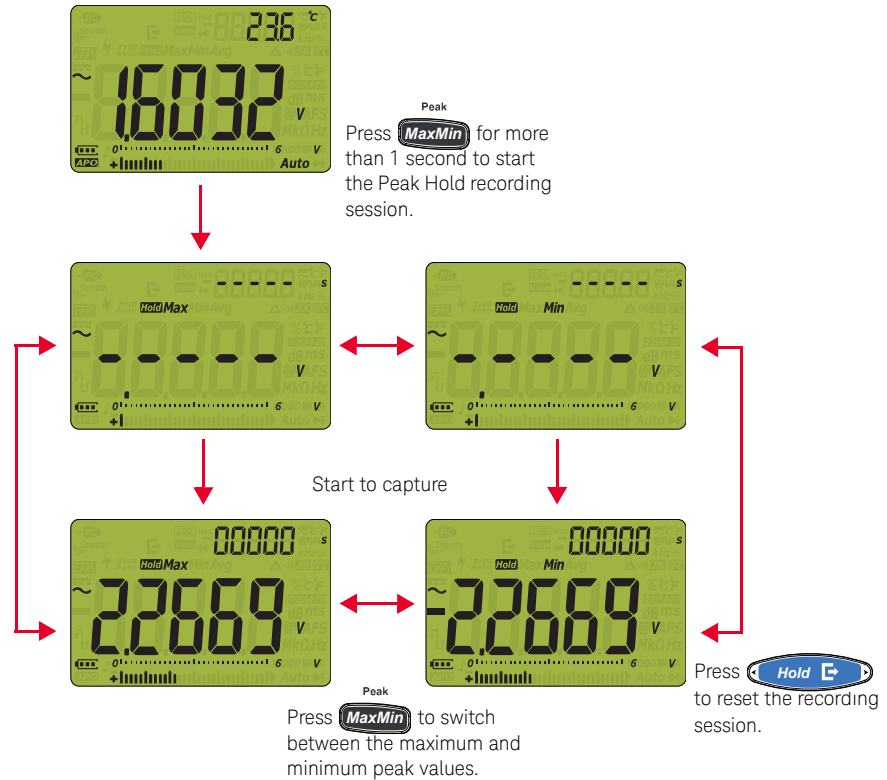

Figure 3-6 Peak hold operation

Freezing the Display (TrigHold and AutoHold)

TrigHold operation

Pressing  activates the TrigHold if the following condition is met:

- The **AHOLD** Setup menu entry is disabled. (Refer to “**Changing the variation count**” on page 119)

In TrigHold operation mode, pressing  will manually trigger the holding of the next measured value. The **Trig** icon flashes before the display is updated.











AutoHold operation

Pressing  activates the AutoHold if the following conditions are met:

- The  Setup menu entry is enabled. (Refer to “**Changing the variation count**” on page 119)

The AutoHold operation monitors the input signal and updates the display, and if enabled, emits a beep whenever a new stable measurement is detected. The AutoHold mode will be triggered when the input signal varies more than a selected adjustable (AutoHold threshold) variation count (default 50 counts).

Changing the default AutoHold threshold count

- 1 Press  while turning the rotary switch to access the Setup menu.
- 2 Press  or  on  until **AHOLD** is shown on the secondary display.
- 3 Press  or  to edit the value shown on the primary display.
- 4 Press  or  on  to navigate to the consecutive values, then repeat **step 3** to edit.
- 5 Press  to save the changes. Press and hold  until the multimeter restarts.

NOTE

If the reading value is unable to reach a stable state, the reading value will not be updated.

Recording Measurement Data (Data Logging)

The Data Logging function provides you the convenience of recording test data for future review or analysis. Since data is stored in the nonvolatile memory, the data remains saved even when the multimeter is turned OFF or if the battery is replaced.

The Data Logging feature collects measurement information over a user-specified duration. There are four data logging options that can be used to capture measurement data: manual (HAnd), interval (Auto), event (Trig), or export (E).

A manual log stores an instance of the measured signal each time  is pressed for more than 1 second. See [page 106](#).

An interval log stores a record of the measured signal at a user-specified interval. See [page 106](#).

An event log stores a record of the measured signal each time a trigger condition is satisfied. See [page 108](#).







A export log stores a record of the measured signal and exports it via the multimeter's optical communication port each time  is pressed. See [page 109](#).

Table 3-1 Data logging maximum capacity



Data logging option	Maximum capacity for saving
Export (E)	100
Manual (HAnd)	100
Interval (Auto)	10000
Event (Trig)	Shares the same memory with Interval logging

Before starting a recording session, set up the multimeter for the measurements to be recorded.

Select the data logging option

- 1 Press  while turning the rotary switch to access the Setup menu.
- 2 Press  or  on  until **TYPE** is shown on the secondary display and the **LOG** icon appears to the left of the secondary display.
- 3 Press  or  to change the data logging option.

Available options: **HAnd**, **Auto**, or **Trig**.

- 4 Press  to save the changes. Press and hold  until the multimeter restarts.

Performing manual logs (HAnd)

Ensure that **HAnd** is selected as the data logging option in the multimeter's Setup.



- 1 Press  for more than 1 second to store the present input signal value and function. **LOG H** and the log entry number are displayed at the top of the display. The display will return to normal after a short while (around 1 second).



Figure 3-7 Manual log display

- 2 Repeat **step 1** again to save the next input signal value.

The maximum number of readings that can be stored for the manual log is 100 entries.











When all entries are occupied, **FULL** will be shown in the secondary display when  is pressed for more than 1 second.

See the **Reviewing Previously Recorded Data (View)** section later in this manual to review or erase the recorded entries.

Performing interval logs (AUto)

Ensure that **AUto** is selected as the data logging option in the multimeter's Setup.

Set the recording interval duration

- 1 Press  while turning the rotary switch to access the Setup menu.
- 2 Press  or  on  until **t, nE** is shown on the secondary display and the **LOG** icon appears to the left of the secondary display.
- 3 Press  or  to change the duration or a recording interval from 1 to 99999 seconds (default 1 second).
- 4 Press  or  on  to navigate to the consecutive values, then repeat **step 3** to edit.
- 5 Press  to save the changes. Press and hold  until the multimeter restarts.

The duration set in the steps above will determine how long each recording interval takes. The input signal value at the end of each interval will be recorded and saved into the multimeter's memory.

Start the interval log mode

- 1 Press  for more than 1 second to start interval log mode. **LOG** A and the log entry number are displayed at the top of the display. Subsequent readings are automatically recorded into the multimeter's memory at the interval specified in the Setup menu.

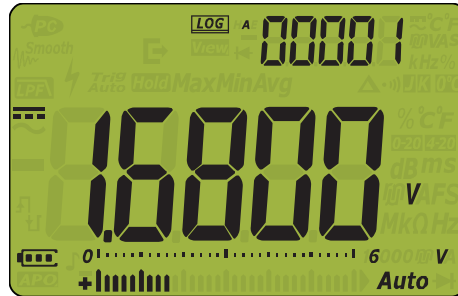



Figure 3-8 Interval log display

- 2 Press  for more than 1 second to exit the interval log mode.

The maximum number of readings that can be stored for the interval log is 10000 entries.

When all entries are occupied, **FULL** will be shown in the secondary display when  is pressed for more than 1 second.

The interval and event log share the same memory buffer (10000 entries). Increased usage of the interval log entries will lead to the decrease of the maximum entries for the event log, and vice versa.

See the **Reviewing Previously Recorded Data (View)** section later in this manual to review or erase the recorded entries.

NOTE

When the interval log recording session is running, all other keypad operations are

disabled; except for , which, when pressed for more than 1 second, will stop and exit the recording session. Furthermore, APO (Auto Power-Off) is disabled during the recording session.

Performing event logs (triG)

Ensure that **triG** is selected as the data logging option in the multimeter's Setup.

Event logs are used only with the following modes:

- TrigHold and AutoHold ([page 104](#))
- MaxMin recording ([page 100](#))
- Peak recording ([page 102](#))

Event records are triggered by the measured signal satisfying a trigger condition set by the measurement function used in the following modes:

Table 3-2 Event log trigger conditions

Modes	Trigger condition
	<i>The input signal value is recorded:</i>
TrigHold	Each time  is pressed.
AutoHold	When the input signal changes more than the variation count.
MaxMin	When a new maximum (or minimum) value is recorded. The average and present readings are not recorded in the Event log.
Peak	When a new peak (maximum or minimum) value is recorded.

Start the event log mode

- 1 Select one of the four modes stated in [Table 3-2](#).
- 2 Press  for more than 1 second to start event log mode. **LOG** ϵ and the log entry number are displayed at the top of the display. Subsequent readings are automatically recorded into the multimeter's memory every time a trigger condition specified in [Table 3-2](#) is satisfied. The display will return to normal after a short while (around 1 second).

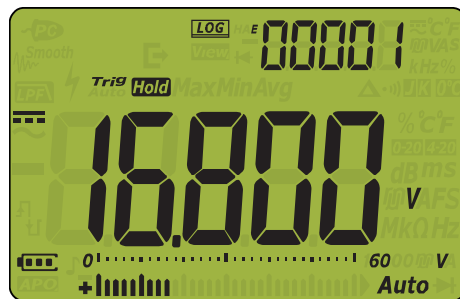



Figure 3-9 Event log display

- 3 Press  for more than 1 second to exit the event log mode.

The maximum number of readings that can be stored for the event log is 10000 entries.

When all entries are occupied, **FULL** will be shown in the secondary display when  is pressed for more than 1 second.

The event and interval log share the same memory buffer (10000 entries). Increased usage of the event log entries will lead to the decrease of the maximum entries for the interval log, and vice versa.

See the **Reviewing Previously Recorded Data (View)** section later in this manual to review or erase the recorded entries.

NOTE

APO (Auto Power-Off) is disabled during the recording session.

Performing export logs





- 1 Press  during measurement to store the present input signal value.
 - a In TrigHold mode, **LOG** and  are displayed at the top of the display, along with **Trig Hold**. The **LOG** and  will disappear after a short while (around 1 second), but the **Trig Hold** will remain.
 - b In AutoHold mode, **LOG** and  are displayed at the top of the display, along with **Auto Hold**. The **LOG** and  will disappear after a short while (around 1 second), but the **Auto Hold** will remain.



Figure 3-10 Export log display (TrigHold mode)

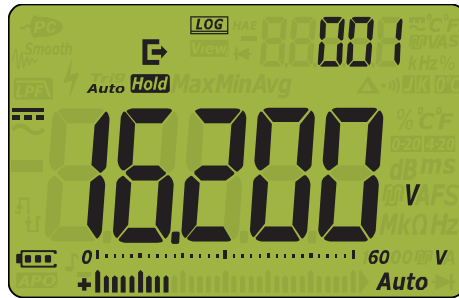



Figure 3-11 Export log display (AutoHold mode)

2 Repeat **step 1** again to save the next input signal value.



The maximum number of readings that can be stored for the export log is 100 entries.

When all entries are occupied, **FULL** will be shown in the secondary display when  is pressed for more than 1 second.

See the **Reviewing Previously Recorded Data (View)** section later in this manual to review or erase the recorded entries.

Reviewing Previously Recorded Data (View)

Viewing data stored in the multimeter's memory is performed through the  key.

- 1 Press  for more than 1 second to enter the multimeter's View mode. Press  again to scroll through the manual (H), interval (A), event (E), or export () previously stored records.

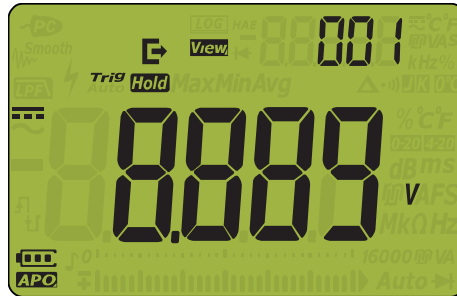









Figure 3-12 View display

If nothing has been recorded, the secondary display will show horizontal lines instead.



Figure 3-13 Empty view display

- 2 Select the desired log type to view its entries.
 - i Press  on  to jump to the first stored entry.
 - ii Press  on  to jump to the last stored entry.
 - iii Press  to view the next stored entry. The index number increases by one.
 - iv Press  to view the previous stored entry. The index number decreases by one.
- 3 Press  to delete the last stored entry, or press for more than 1 second to clear all entries for the selected log type.
- 4 Press  for more than 1 second to exit the View mode.

Sanitizing the Log Memories

You have the option to sanitize the log memories of your multimeter. This operation erases the log memories of your multimeter thoroughly. The data stored in the multimeter's memory will not be able to be reconstructed in any way after the data sanitization operation.

Prior to sanitizing the log memories, ensure that all manual (**H**), interval (**A**), event (**E**), or export (**E**) entries have been cleared (see **step 3**).

When all entries are cleared, press and hold  for more than 1 second to sanitize the log entries.

CAUTION

The data sanitization operation may take up to 1-2 minutes to complete. Do not press any keys or turn the rotary switch until the data sanitization operation is completed.

Keysight U1281A/U1282A
Handheld Digital Multimeter
User's Guide

4 Multimeter Setup Options

Using the Setup Menu	114
Editing numerical values	115
Setup Menu Summary	116
Setup Menu Items	119
Changing the variation count	119
Enabling smooth mode	120
Changing the Auto Power-Off and backlight timeouts	121
Changing the recording option	122
Changing the sample interval duration	123
Setting a custom dBm reference impedance	124
Changing the thermocouple type	125
Changing the temperature unit	126
Changing the beep frequency	127
Changing the startup sound	128
Changing the continuity type	129
Changing the continuity alert type	130
Changing the battery type	131
Resetting the multimeter's Setup options	132
Changing the remote button function	133
Setting the display count	134
Setting the data refresh rate	135
Setting the input impedance	136
Enabling the DC path filter	137
Enabling the AC path filter (for U1282A only)	138

The following sections describe how to change the preset features of your multimeter.

















Using the Setup Menu

The multimeter's Setup menu allows you to change a number of nonvolatile preset features. Modifying these settings affects the general operation of your multimeter across several functions. Select a setting to edit to perform one of the following:

- Switch between two values, such as on or off.
- Scroll through multiple values from a predefined list.
- Decrease or increase a numerical value within a fixed range.

To contents of the Setup menu are summarized in **Table 4-2**.

Table 4-1 Setup menu key functions



Legend	Description
	<p>Press  while turning the rotary switch from the OFF position to any ON position to access the Setup menu.</p> <p>Press and hold  until the multimeter restarts to exit the Setup menu.</p> <p>While the menu item is flashing, press  to discard your changes.</p>
	Press  or  on  to step through the menu items.
 	<p>Press  or  at each menu item to change the preset settings. The last digit of the menu item (in the primary display) will flash to indicate that you can now change the values shown in the primary display.</p> <p>Press  or  again to switch between two values, to scroll through multiple values from a list, or to decrease or increase a numerical value.</p>
	While the menu item is flashing, press  to save your changes.



NOTE



The multimeter will automatically exit the Setup menu after 30 seconds of inactivity.

Editing numerical values



When editing numerical values, use  to position the cursor on a numerical digit.

- Press  to move the cursor to the left, and
- Press  to move the cursor to the right.

When the cursor is positioned over a digit, use the  and  keys to change the numerical digit.

- Press  to increment the digit, and
- Press  to decrement the digit.

When you have completed your changes, save the new numerical value by pressing

. (Alternatively, if you wish to discard the changes you made, press .

Press and hold  to exit the Setup menu.

Setup Menu Summary

The Setup menu items are summarized in the table below. Click the respective “Learn more” pages for more information on each menu item.





Table 4-2 Setup menu item descriptions

Legend	Available settings	Description	Learn more on:
AHOLD	0001.d to 9999.d counts 0001.E to 9999.E counts	Set the multimeter’s AutoHold and Smooth Mode threshold count from (0001.d) to (9999.d) or (0001.E) to (9999.E). Multiply the count by 10 for high (dddd) resolution. You can also disable this feature (d). Default is (0050.d).	page 104 and page 119
t ₁ nE	0001.d to 9999.d counts 0001.E to 9999.E counts	Set the Smooth Mode time from (0001.d) to (9999.d) or (0001.E) to (9999.E). You can also disable Smooth Mode (d). Default is (0009.d).	page 104 and page 123
RoFF	01.d to 99.d minutes 01.E to 99.E minutes	Set the Auto Power-Off timeout period from 1 to 99 minutes (1 hour, 39 minutes). You can also disable this feature (d). Default is (15.E).	page 25 and page 121
bl, t	01.d to 99.d seconds 01.E to 99.E seconds	Set the LCD and keypad backlight timeout period from 1 to 99 seconds (1 minute, 39 seconds). You can also disable this feature (d). Default is (15.E).	page 25 and page 121
tYPE	HAnd, AUto, or triG	Set the multimeter’s data logging option (manual log, interval log, or event log). Default is manual log (HAnd).	page 105 and page 122
t ₁ nE	00001 to 99999 s	Set the logging duration for interval logging from 1 to 99999 seconds (1 day, 3 hours, 46 minutes, 39 seconds). Default is 1 second.	page 106 and page 123
dBref	0001 to 9999 Ω	Set the dBm reference impedance value from 1 Ω to 9999 Ω. Default is 50 Ω.	page 60 and page 124
COUPL	tYPE J or tYPE K	Set the multimeter’s thermocouple type (type J or type K). Default is type K.	page 76 and page 125

Table 4-2 Setup menu item descriptions (continued)

Legend	Available settings	Description	Learn more on:
Unit	°C-°F, °F, °F-°C, °C	Set the multimeter's temperature unit (Celsius/Fahrenheit, Fahrenheit, Fahrenheit/Celsius, or Celsius). Default is °C (Celsius).	page 126
BEeP	3200 Hz, 3268 Hz, 3339 Hz, 3413 Hz, 3491 Hz, 3572 Hz, 3657 Hz, 3746 Hz, 3840 Hz, 3938 Hz, 4042 Hz, 4151 Hz, 4267 Hz, or oFF	Set the multimeter's beep frequency from 3200 Hz to 4267 Hz. You may also disable this feature (oFF). Default is 3840 Hz.	page 127
Sound	MELo, bEeE, or oFF	Set the multimeter's startup sound to either melody (MELo), beep (bEeE), or disable this feature (oFF). Default is (bEeE).	page 128
tyPE	SHort, oPEn, or tonE	Set the multimeter's continuity type to (SHort), (oPEn), or (tonE). Default is (SHort).	page 65 and page 129
HorN	bE.rL, bE.--, --.rL, or ---.--	Set the multimeter's alert type to beeper (bE.--), flashing red LED (--.rL), both at once (bE.rL), or none (---.--). Default is (bE.rL).	page 130
BAE	Pri or SEC	Selects the kind of batteries the multimeter is using, either primary (Pri), or secondary (SEC). Default is (Pri).	page 22 and page 130
rESEt	YES or no	Reset the multimeter to its factory default settings. Default is (no).	page 132
rEñ-b	b1.d to b7.d b1.E to b7.E	Maps the remote probe button to a specific function. You may also disable this feature (d). Default is (b7.E)	page 133
d ₁ SP	dddd or dddd	Set the display count to high (dddd) or low (ddd) resolution. Default is (dddd)	page 134
d-UPd	5 or 40	Set the multimeter's display refresh rate to either 5 or 40 times/second. Default is 5 times/second	page 135

Table 4-2 Setup menu item descriptions (continued)

Legend	Available settings	Description	Learn more on:
	10 M Ω or 1000 M Ω	Set the multimeter's input impedance for mV measurement to either 10 M Ω or > 1000 M Ω . Default is 10 M Ω .	page 51 , page 53 , and page 136
	oFF or on	Enable and disables the Filter for DC voltage or current measurement. Default is (oFF).	page 137
	oFF or on	Enables and disables the  for AC voltage or current measurement. Default is (oFF).	page 138

NOTE

Press and hold the  button for more than 1 second to select the temperature unit menu for settling.

Setup Menu Items

Changing the variation count

This setting is used with the multimeter's AutoHold feature (see [page 104](#)). The default setting is 50 counts (0050) based on the low definition display (dddd). The default setting is multiplied by 10 when you switch to the high definition display (ddddd). When the variation of the measured value exceeds the value of the variation count, the AutoHold feature will be ready to trigger.

Parameter	Range	Default setting
AHoLd	(0001.d to 9999.d) or (0001.E to 9999.E)	0050.d (disabled)

To change the variation count:













- 1 Press  while turning the rotary switch to access the Setup menu.
- 2 Press  or  on  until **AHoLd** is shown on the secondary display.



Figure 4-1 AHoLd display





- 3 Press  or  to set the variation count.
- 4 Press  or  on  to navigate to the consecutive values, then repeat **step 3** to edit.
- 5 Press  to save your changes, or press  to discard your changes.
- 6 Press and hold  until the multimeter restarts to return to normal operation.

Enabling smooth mode

Smooth is used to smoothen the refresh rate of the readings in order to reduce the impact of unexpected noise and to help you achieve a stable reading. You can permanently enable or disable Smooth from the Setup menu. The smooth refresh rate can be set from 0001 to 9999. The smooth time is defined as the set value +1. Smooth will be restarted when the variation count is exceeded, when the range is changed, or after a multimeter function or feature is enabled. The variation count is set to the value used for the AutoHold feature (“**Changing the variation count**” on page 119).

Parameter	Range	Default setting
tiME	(0001.d to 9999.d) or (0001.E to 9999.E)	0009.d (disabled)

To enable Smooth:

- 1 Press  while turning the rotary switch to access the Setup menu.
- 2 Press  or  on  until $t_i \bar{n}E$ is shown on the secondary display and the  icon appears to the left of the primary display.

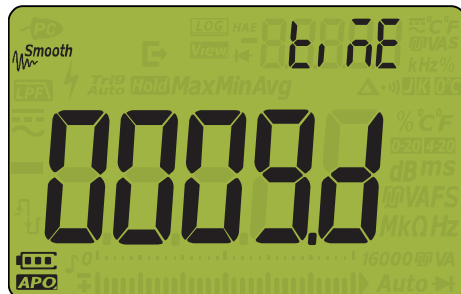









Figure 4-2 tiME display - Smooth





- 3 Press  or  to set the Smooth refresh rate. To permanently enable Smooth, change the last digit shown from d (disabled) to E (enabled).
- 4 Press  or  on  to navigate to the consecutive values, then repeat **step 3** to edit.
- 5 Press  to save your changes, or press  to discard your changes.
- 6 Press and hold  until the multimeter restarts to return to normal operation.

Changing the Auto Power-Off and backlight timeouts

The multimeter's automatic power-off (see [page 25](#)) and backlight (see [page 25](#)) features use timers to determine when to automatically turn the multimeter off and when to turn off the backlight.

Parameter	Range	Default setting
AoFF	(01.d to 99.d) or (01.E to 99.E) minutes	(15.E) - 15 minutes, enabled
bLit	(01.d to 99.d) or (01.E to 99.E) seconds	(15.E) - 15 seconds, enabled

To change the Auto Power-Off and backlight timeout periods:

- 1 Press  while turning the rotary switch to access the Setup menu.
- 2 Press  or  on  until **AoFF** or **bLit** is shown on the secondary display.

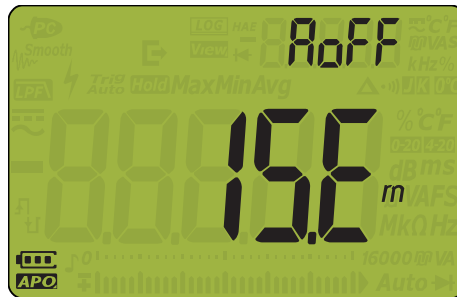









Figure 4-3 AoFF display



Figure 4-4 bLit display





- 3 Press  or  to change the timeout period. To enable or disable the timeout feature, change the last digit shown from **E** (enabled) to **d** (disabled).
- 4 Press  or  on  to navigate to the consecutive values, then repeat **step 3** to edit.
- 5 Press  to save your changes, or press  to discard your changes.
- 6 Press and hold  until the multimeter restarts to return to normal operation.

Changing the recording option

This setting is used with the multimeter's Data Logging feature (see [page 105](#)). There are three available recording options for the multimeter's Data Logging feature.

Parameter	Range	Default setting
tYPE	HAnd, triG, or AUto	HAnd

To change the recording option:

- 1 Press  while turning the rotary switch to access the Setup menu.
- 2 Press  or  on  until **tYPE** is shown on the secondary display and the **LOG** icon appears to the left of the secondary display.

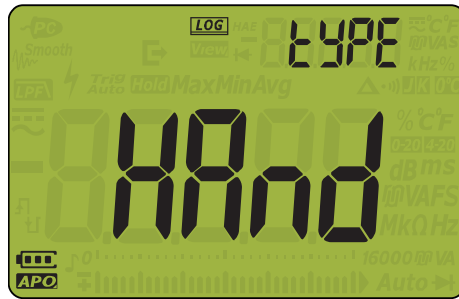







Figure 4-5 tYPE display - data logging

- 3 Press  or  to set the recording option.
- 4 Press  to save your changes, or press  to discard your changes.
- 5 Press and hold  until the multimeter restarts to return to normal operation.

Changing the sample interval duration

This setting is used with the multimeter's Interval Data Logging feature (see [page 106](#)). The multimeter will record a measurement value at the beginning of every sample interval.

Parameter	Range	Default setting
tiME	(1 to 99999) s	1 s

To change the sample interval duration:













- 1 Press  while turning the rotary switch to access the Setup menu.
- 2 Press  or  on  until $t_i \bar{n}E$ is shown on the secondary display and the  icon appears to the left of the secondary display.



Figure 4-6 tiME display - data logging

- 3 Press  or  to set the sample interval duration.
- 4 Press  or  on  to navigate to the consecutive values, then repeat **step 3** to edit.
- 5 Press  to save your changes, or press  to discard your changes.
- 6 Press and hold  until the multimeter restarts to return to normal operation.

Setting a custom dBm reference impedance

This setting is used with dB measurements (see [page 60](#)). The dBm function is logarithmic, and is based on a calculation of power delivered to a reference impedance (resistance), relative to 1 mW.

Parameter	Range	Default setting
dbrEF	(1 to 9999) Ω	50 Ω

To change the dBm reference impedance value:













- 1 Press  while turning the rotary switch to access the Setup menu.
- 2 Press  or  on  until **dbrEF** is shown on the secondary display.



Figure 4-7 dbrEF display

- 3 Press  or  to set the dBm reference impedance value.
- 4 Press  or  on  to navigate to the consecutive values, then repeat **step 3** to edit.
- 5 Press  to save your changes, or press  to discard your changes.
- 6 Press and hold  until the multimeter restarts to return to normal operation.

Changing the thermocouple type

This setting is used with temperature measurements. Select a thermocouple type that matches the thermocouple sensor you are using for temperature measurements.

Parameter	Range	Default setting
CoUPL	tYPE K or tYPE J	tYPE K

To change the thermocouple type:









- 1 Press  while turning the rotary switch to access the Setup menu.
- 2 Press  or  on  until **CoUPL** is shown on the secondary display.



Figure 4-8 CoUPL display

- 3 Press  or  to change the thermocouple type.
- 4 Press  to save your changes, or press  to discard your changes.
- 5 Press and hold  until the multimeter restarts to return to normal operation.

NOTE

This Setup menu item is only applicable for the U1282A.



Changing the temperature unit

CAUTION

This Setup item is locked for certain regions. Always set the temperature unit display per the official requirements and in compliance with the National laws of your region.



Press  for > 1 second to unlock this setting.

This setting is used with temperature measurements (see [page 76](#)). Four combinations of displayed temperature unit(s) are available:

- Celsius only: Temperature measured in °C.
- Fahrenheit/Celsius: During temperature measurements, press  for > 1 second to switch between °F and °C.
- Celsius/Fahrenheit: During temperature measurements, press  for > 1 second to switch between °C and °F.
- Fahrenheit only: Temperature measured in °F.

Parameter	Range	Default setting
Unit	°C, °F/°C, °C/°F, or °F	°C

To change the temperature unit:

- 1 Press  while turning the rotary switch to access the Setup menu.
- 2 Press ◀ or ▶ on  until **Unit** is shown on the secondary display.

NOTE







Press  for > 1 second to unlock this setting.



Figure 4-9 Unit display

- 3 Press  or  to change the temperature unit.
- 4 Press  to save your changes, or press  to discard your changes.
- 5 Press and hold  until the multimeter restarts to return to normal operation.

Changing the beep frequency

The multimeter's beeper alerts users to the presence of circuit continuities, operator errors such as incorrect lead connections for the selected function, and newly sensed values for MaxMin and Peak recordings.

Parameter	Range	Default setting
bEEP	3200 Hz, 3268 Hz, 3339 Hz, 3413 Hz, 3491 Hz, 3572 Hz, 3657 Hz, 3746 Hz, 3840 Hz, 3938 Hz, 4042 Hz, 4151 Hz, 4267 Hz, or oFF	3840 Hz

To change the beep frequency:













- 1 Press  while turning the rotary switch to access the Setup menu.
- 2 Press  or  on  until **bEEP** is shown on the secondary display.



Figure 4-10 bEEP display





- 3 Press  or  to change the beep frequency. Select **oFF** to disable the beeper feature.
- 4 Press  or  on  to navigate to the consecutive values, then repeat **step 3** to edit.
- 5 Press  to save your changes, or press  to discard your changes.
- 6 Press and hold  until the multimeter restarts to return to normal operation.

Changing the startup sound

During startup, the multimeter emits a sound and displays the model number and the installed firmware version. You may change the sound or disable it.

Parameter	Range	Default setting
SoUnd	MELo, bEEE, or oFF	bEEE

To change the startup sound:

- 1 Press  while turning the rotary switch to access the Setup menu.
- 2 Press  or  on  until **SoUnd** is shown on the secondary display.

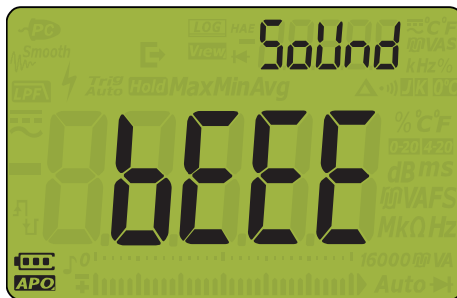







Figure 4-11 SoUnd display

- 3 Press  or  to set the startup sound type. Select **oFF** to disable the startup sound.
- 4 Press  to save your changes, or press  to discard your changes.
- 5 Press and hold  until the multimeter restarts to return to normal operation.

Changing the continuity type

This setting is used to indicate the circuit type at which the alert sounds for resistance and diode measurements. You may choose the alert type under [page 130](#).

Parameter	Range	Default setting
tYPE	oPEn, SHort, or tonE	SHort

To change the continuity type:











- 1 Press  while turning the rotary switch to access the Setup menu.
- 2 Press  or  on  until **tYPE** is shown on the secondary display and the  icon appears below the secondary display.



Figure 4-12 tYPE display - continuity

- 3 Press  or  to set the continuity type.
- 4 Press  to save your changes, or press  to discard your changes.
- 5 Press and hold  until the multimeter restarts to return to normal operation.

Changing the continuity alert type

This setting is used to define the continuity alert. You may choose between the beeper, the red light-emitting diode (LED), both, or none.

Parameter	Range	Default setting
Horn	(bE.rL), (bE.--), (--.rL), or (--.--)	(bE.rL)

To change the continuity alert type:













- 1 Press  while turning the rotary switch to access the Setup menu.
- 2 Press  or  on  until **Horn** is shown on the secondary display and the  icon appears below the secondary display.



Figure 4-13 Horn display

- 3 Press  or  to set the continuity alert type.
- 4 Press  or  on  to navigate to the consecutive values, then repeat **step 3** to edit.
- 5 Press  to save your changes or press  to discard your changes.
- 6 Press and hold  until the multimeter restarts to return to normal operation.

Changing the battery type

This setting is used to change the battery type. The battery capacity indication is based on this setting. The Primary (**Pri**) setting is used for non-rechargeable batteries and the Secondary (**SEC**) setting is used for rechargeable batteries.

Parameter	Range	Default setting
bAt	Pri or SEC	Pri

To change the battery type:









- 1 Press  while turning the rotary switch to access the Setup menu.
- 2 Press  or  on  until **bAt** is shown on the secondary display.



Figure 4-14 bAt display

- 3 Press  or  to change the battery type.
- 4 Press  to save your changes, or press  to discard your changes.
- 5 Press and hold  until the multimeter restarts to return to normal operation.

Resetting the multimeter's Setup options

The multimeter's Setup options can be reset to its default values through the Setup menu.

Parameter	Range	Default setting
rESet	YES or no	no









- 1 Press  while turning the rotary switch to access the Setup menu.
- 2 Press  or  on  until **rESEt** is shown on the secondary display.



Figure 4-15 rESEt display

- 3 Press  or  to select **YES**.
- 4 Press  to perform the reset, or press  to discard your changes.
- 5 The multimeter will beep once and return to the first Setup menu item (**PHoLd**).

NOTE

All the settings will be reset to their default values except the temperature units.

Changing the remote button function

This setting is used to enable or disable the remote probe button and map the remote probe button's function to a multimeter soft key.

Parameter	Range	Default setting
rEM-b	(b1.E to b7.E)	(b7.E)

To change the remote button function:













- 1 Press  while turning the rotary switch to access the Setup menu.
- 2 Press  or  on  until **rEñ-b** is shown on the secondary display.



Figure 4-16 rEM-b display

- 3 Press  or  to change the remote button function, according to the corresponding numbers:

Number	Function
b1	MaxMin/Peak
b2	ΔNull/Vsense
b3	Range/Auto
b4	Hz/Log
b5	Backlight/Dual
b6	Shift/View
b7	Hold

- 4 Press  or  on  to navigate to the consecutive values, then repeat **step 3** to edit.
- 5 Press  to save your changes, or press  to discard your changes.
- 6 Press and hold  until the multimeter restarts to return to normal operation.

Setting the display count

This setting is used to set the multimeter's display count resolution. You may choose between a high resolution and a low resolution.

Parameter	Range	Default setting
diSP	dddd or dddddd	ddddd

To change the display count:









- 1 Press  while turning the rotary switch to access the Setup menu.
- 2 Press  or  on  until **d1 SP** is shown on the secondary display.



Figure 4-17 diSP display

- 3 Press  or  to set the display count.
- 4 Press  to save your changes, or press  to discard your changes.
- 5 Press and hold  until the multimeter restarts to return to normal operation.

Setting the data refresh rate

This setting is used to set the multimeter's data refresh rate for voltage, current, resistance, and diode measurements.

NOTE

To perform high-speed measurements of voltage, current, resistance, and diode, set the data refresh rate to 40 times per second. This will produce more than double the measurement speed for these measurements.

CMRR and NMRR rejections are not applicable for this high-speed measurement mode. Under this specialized condition, this mode provides reduced accuracy results at 40 readings per second.

In applications where sample-to-sample levels vary widely, a longer settling time is required for each new reading.

The count resolution for the 40 times per second data refresh rate is 6,000, and the resolution for the 5 times per second data refresh rate is 60,000.

Parameter	Range	Default setting
d-UPd	5 or 40 times per second	5 times per second

To change the refresh rate:









- 1 Press  while turning the rotary switch to access the Setup menu.
- 2 Press  or  on  until **d-UPd** is shown on the secondary display.



Figure 4-18 d-UPd display

- 3 Press  or  to set the data refresh rate.
- 4 Press  to save your changes, or press  to discard your changes.
- 5 Press and hold  until the multimeter restarts to return to normal operation.

Setting the input impedance

This setting is used with mV measurements. You can manually set the impedance, either for a 10 M Ω reading, or for a reading that is more than 1 G Ω .

Parameter	Range	Default setting
inPUt	10 M Ω or 1000 M Ω	10 M Ω

To change the input impedance:









- 1 Press  while turning the rotary switch to access the Setup menu.
- 2 Press  or  on  until **inPUt** is shown on the secondary display.



Figure 4-19 inPUT display

- 3 Press  or  to set the input impedance.
- 4 Press  to save your changes, or press  to discard your changes.
- 5 Press and hold  until the multimeter restarts to return to normal operation.

Enabling the DC path filter

This filter is used with DC voltage and current measurements. The AC signal will be attenuated to the lowest possible, increasing the NMRR for DC measurement. This will result in reduced AC noise.

Parameter	Range	Default setting
LPF	oFF or on	oFF

To enable the DC path filter:











- 1 Press  while turning the rotary switch to access the Setup menu.
- 2 Press  or  on  until **LPF** is shown on the secondary display and the  icon appears to the right of the secondary display.



Figure 4-20 LPF display - DC

- 3 Press  or  to enable or disable the filter.
- 4 Press  to save your changes, or press  to discard your changes.
- 5 Press and hold  until the multimeter restarts to return to normal operation.

Enabling the AC path filter (for U1282A only)

This low-pass filter is used with AC voltage and current measurements. The AC signal will be attenuated in accordance to the specified low-pass filter (LPF) frequency.

Parameter	Range	Default setting
LPF	oFF or on	oFF

To enable the AC path filter:











- 1 Press  while turning the rotary switch to access the Setup menu.
- 2 Press  or  on  until **LPF** is shown on the secondary display and the  icon appears to the right of the secondary display.



Figure 4-21 LPF display - AC

- 3 Press  or  to enable or disable the filter.
- 4 Press  to save your changes, or press  to discard your changes.
- 5 Press and hold  until the multimeter restarts to return to normal operation.

Keysight U1281A/U1282A
Handheld Digital Multimeter
User's Guide

5 Characteristics and Specifications

For the characteristics and specifications of the U1281A/U1282A Handheld Digital Multimeter, refer to the datasheet at

<http://literature.cdn.keysight.com/litweb/pdf/5992-0847EN.pdf>.

THIS PAGE HAS BEEN INTENTIONALLY LEFT BLANK.

Keysight U1281A/U1282A
True RMS Multimeter
User's Guide

Appendix A: Shift Functions Using the Shift Key

Default and shift functions **142**













The table below lists the functions shown in the primary display when the  key is pressed, with respect to the multimeter's rotary switch position. Press  to cycle through the available shift functions.

Table A-1 Default and shift functions

Rotary switch position	Function shown in the primary display:	
	Default	When  is pressed
	AC voltage measurement (AC V)	AC voltage measurement (AC V) with Low Pass Filter (LPF)
	AC voltage measurement (AC mV)	AC voltage measurement (AC mV) with Low Pass Filter (LPF)
	DC voltage measurement (DC V)	AC voltage measurement (AC V) AC+DC voltage measurement (AC+DC V)
	DC voltage measurement (DC mV)	AC voltage measurement (AC mV) AC+DC voltage measurement (AC+DC mV)
	Resistance measurement (Ω)	Continuity test ($\bullet \rightarrow \bullet$)
	Diode test (V)	Frequency counter (Hz/MHz)
	Capacitance measurement (F)	Temperature measurement ($^{\circ}\text{C}/^{\circ}\text{F}$)
 With the positive probe inserted into the $\mu\text{-mA}$ terminal	DC current measurement (DC $\mu\text{A}/\text{mA}$)	AC current measurement (AC $\mu\text{A}/\text{mA}$) AC+DC current measurement (AC+DC $\mu\text{A}/\text{mA}$)
 With the positive probe inserted into the A terminal	DC current measurement (DC A)	AC current measurement (AC A) AC+DC current measurement (AC+DC A)
	Square wave output (duty cycle mode)	Square wave output (pulse width mode)

Keysight U1281A/U1282A
True RMS Multimeter
User's Guide

Appendix B: Dual Display Combinations Using the Dual Key

Dual display combinations [144](#)



The table below lists the functions shown in the secondary display when the  key is pressed and held for more than 1 second, with respect to the multimeter's rotary switch position. Press  for more than 1 second to cycle through the available dual display combinations.

Table B-1 Dual display combinations





Rotary switch position	Default function		Function shown (when  is pressed) in the:	
	Primary display	Secondary display	Primary display	Secondary display
	AC voltage measurement (AC V)	Ambient temperature	AC voltage measurement (AC V)	AC coupling frequency measurement (Hz)
			dBm measurement (dBm V)	AC voltage measurement (AC V)
			dBV measurement (dBV V)	AC voltage measurement (AC V)
	AC voltage measurement (AC mV)	Ambient temperature	AC voltage measurement (AC mV)	AC coupling frequency measurement (Hz)
			dBm measurement (dBm mV)	AC voltage measurement (AC mV)
			dBV measurement (dBV mV)	AC voltage measurement (AC mV)
	DC voltage measurement (DC V)	Ambient temperature	DC voltage measurement (DC V)	DC coupling frequency measurement (Hz)
			dBm measurement (dBm V)	DC voltage measurement (DC V)
			dBV measurement (dBV V)	DC voltage measurement (DC V)
	AC voltage measurement (AC V)	Ambient temperature	AC voltage measurement (AC V)	AC coupling frequency measurement (Hz)
			dBm measurement (dBm V)	AC voltage measurement (AC V)
			dBV measurement (dBV V)	AC voltage measurement (AC V)
AC+DC voltage measurement (AC+DC V)	Ambient temperature	AC voltage measurement (AC V)	DC voltage measurement (DC V)	
		AC+DC voltage measurement (AC+DC V)	AC coupling frequency measurement (Hz)	
		dBm measurement (dBm V)	AC+DC voltage measurement (AC+DC V)	
		dBV measurement (dBV V)	AC+DC voltage measurement (AC+DC V)	
		AC+DC voltage measurement (AC+DC V)	AC voltage measurement (AC V)	
AC+DC voltage measurement (AC+DC V)	DC voltage measurement (DC V)			

Table B-1 Dual display combinations (continued)







Rotary switch position	Default function		Function shown (when  is pressed) in the:	
	Primary display	Secondary display	Primary display	Secondary display
	DC voltage measurement (DC mV)	Ambient temperature	DC voltage measurement (DC mV)	DC coupling frequency measurement (Hz)
			dBm measurement (dBm mV)	DC voltage measurement (DC mV)
			dBV measurement (dBV mV)	DC voltage measurement (DC mV)
			AC voltage measurement (AC mV)	AC coupling frequency measurement (Hz)
			dBm measurement (dBm mV)	AC voltage measurement (AC mV)
			dBV measurement (dBV mV)	AC voltage measurement (AC mV)
	AC voltage measurement (AC mV)	Ambient temperature	AC voltage measurement (AC mV)	DC voltage measurement (DC mV)
			AC+DC voltage measurement (AC+DC mV)	AC coupling frequency measurement (Hz)
			dBm measurement (dBm mV)	AC+DC voltage measurement (AC+DC mV)
			dBV measurement (dBV mV)	AC+DC voltage measurement (AC+DC mV)
			AC+DC voltage measurement (AC+DC mV)	AC voltage measurement (AC mV)
			AC+DC voltage measurement (AC+DC mV)	DC voltage measurement (DC mV)
Resistance measurement (Ω)	-	-	-	
				Continuity test (••)
	-	-	-	
				Diode test (V)
	-	-	-	
				Frequency counter (Hz/MHz)
	-	-	-	
				Capacitance measurement (F)
	-	-	-	
				Temperature measurement ($^{\circ}\text{C}/^{\circ}\text{F}$)

Table B-1 Dual display combinations (continued)

Rotary switch position	Default function		Function shown (when  is pressed) in the:	
	Primary display	Secondary display	Primary display	Secondary display
	DC current measurement (DC µA/mA)	Ambient temperature	DC current measurement (DC µA/mA)	AC coupling frequency measurement (Hz)
			% (4-20) DC µA/mA	DC current measurement (DC µA/mA)
			% (0-20) DC µA/mA	DC current measurement (DC µA/mA)
	AC current measurement (AC µA/mA)	Ambient temperature	AC current measurement (AC µA/mA)	AC coupling frequency measurement (Hz)
			AC current measurement (AC µA/mA)	DC current measurement (DC µA/mA)
			AC+DC current measurement (AC+DC µA/mA)	AC coupling frequency measurement (Hz)
AC+DC current measurement (AC+DC µA/mA)	Ambient temperature	AC+DC current measurement (AC+DC µA/mA)	AC current measurement (AC µA/mA)	
		AC+DC current measurement (AC+DC µA/mA)	DC current measurement (DC µA/mA)	
		AC+DC current measurement (AC+DC µA/mA)	DC current measurement (DC µA/mA)	
	DC current measurement (DC A)	Ambient temperature	DC current measurement (DC A)	AC coupling frequency measurement (Hz)
			AC current measurement (AC A)	AC coupling frequency measurement (Hz)
			AC current measurement (AC A)	DC current measurement (DC A)
	AC+DC current measurement (AC+DC A)	Ambient temperature	AC+DC current measurement (AC+DC A)	AC coupling frequency measurement (Hz)
			AC+DC current measurement (AC+DC A)	AC current measurement (AC A)
			AC+DC current measurement (AC+DC A)	DC current measurement (DC A)
	Square wave output (duty cycle mode)	Square wave output frequency value	-	-
	Square wave output (pulse width mode)	Square wave output frequency value	-	-



This information is subject to change without notice. Always refer to the English version at the Keysight Web site for the latest revision.

© Keysight Technologies 2015 - 2016
Edition 02, March 31, 2016

Printed in Malaysia



U1281-90003

www.keysight.com